

ORKNEY 1  
Art.Nr. 704142

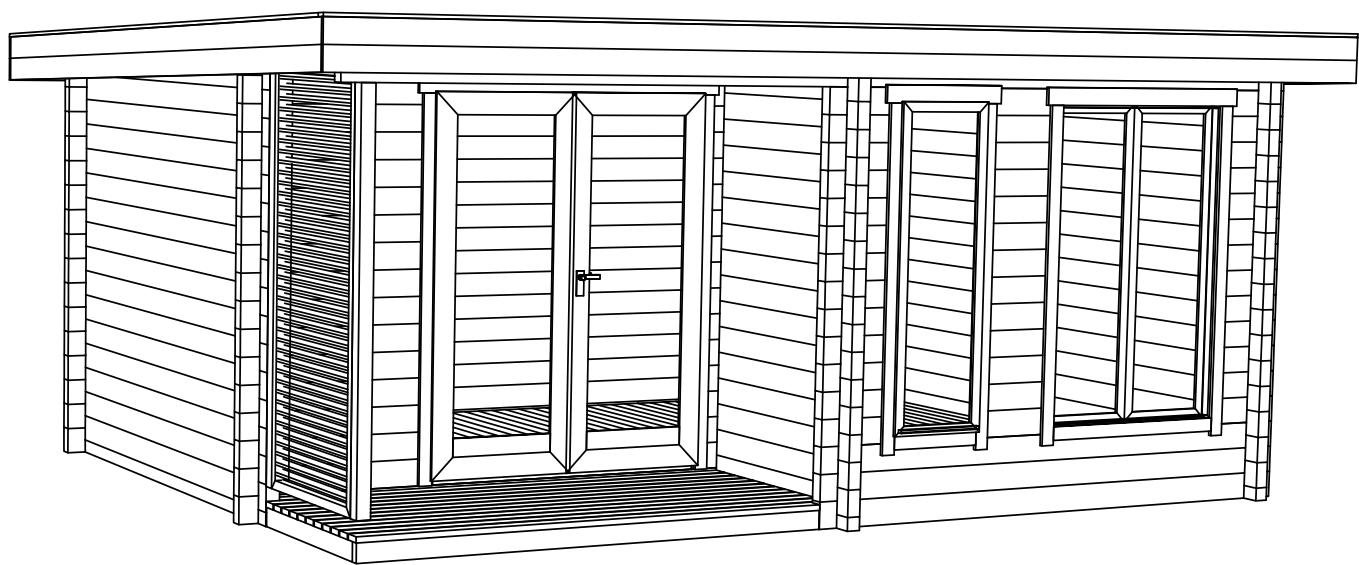

Groundplan - Grundplan - Plan de masse - Planimetria - Plattegrond -  
Põhiplan

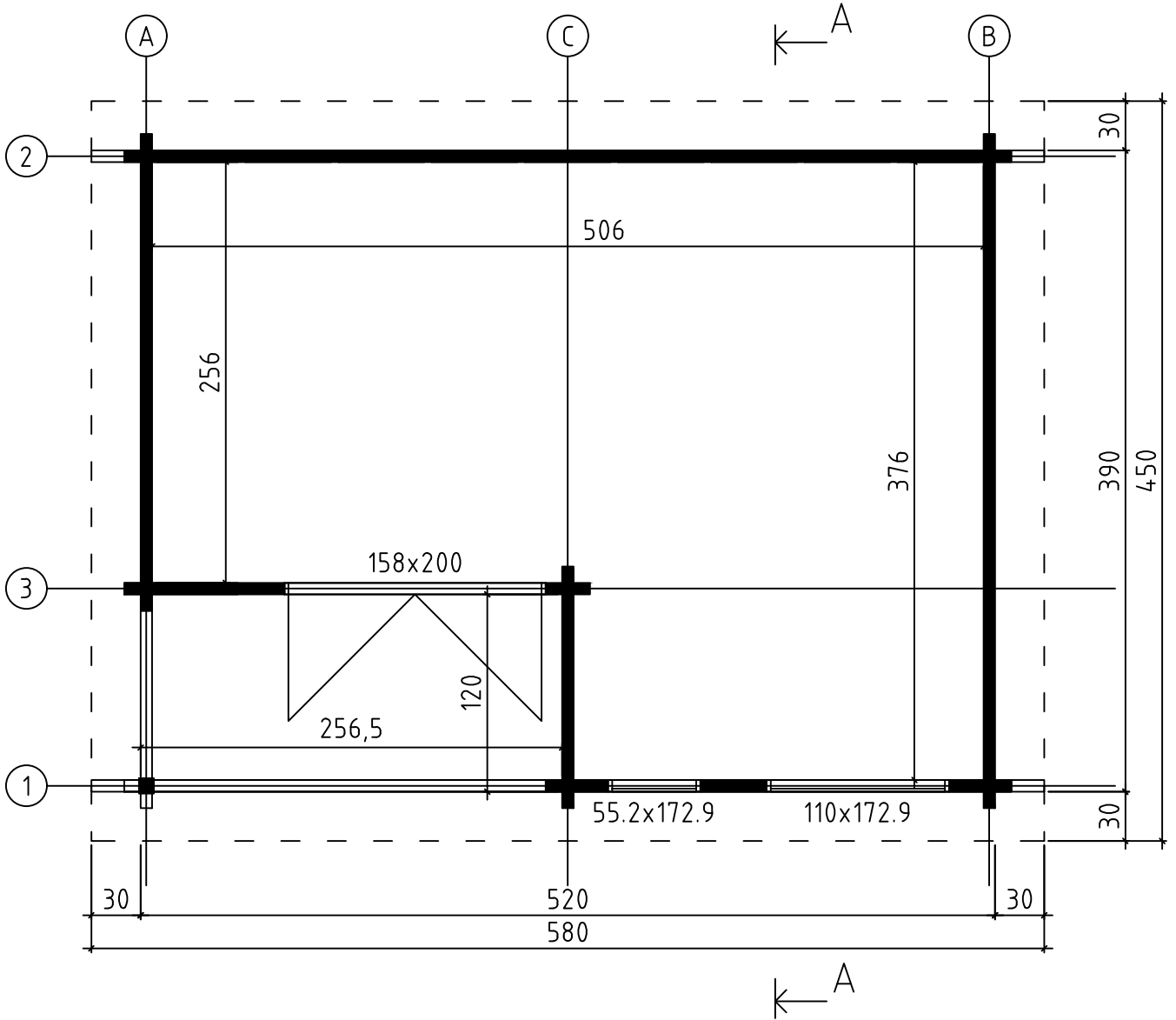

Foundation - Fundament - Fondation - Fundamenta - Fundering -  
Immutatud alusraam

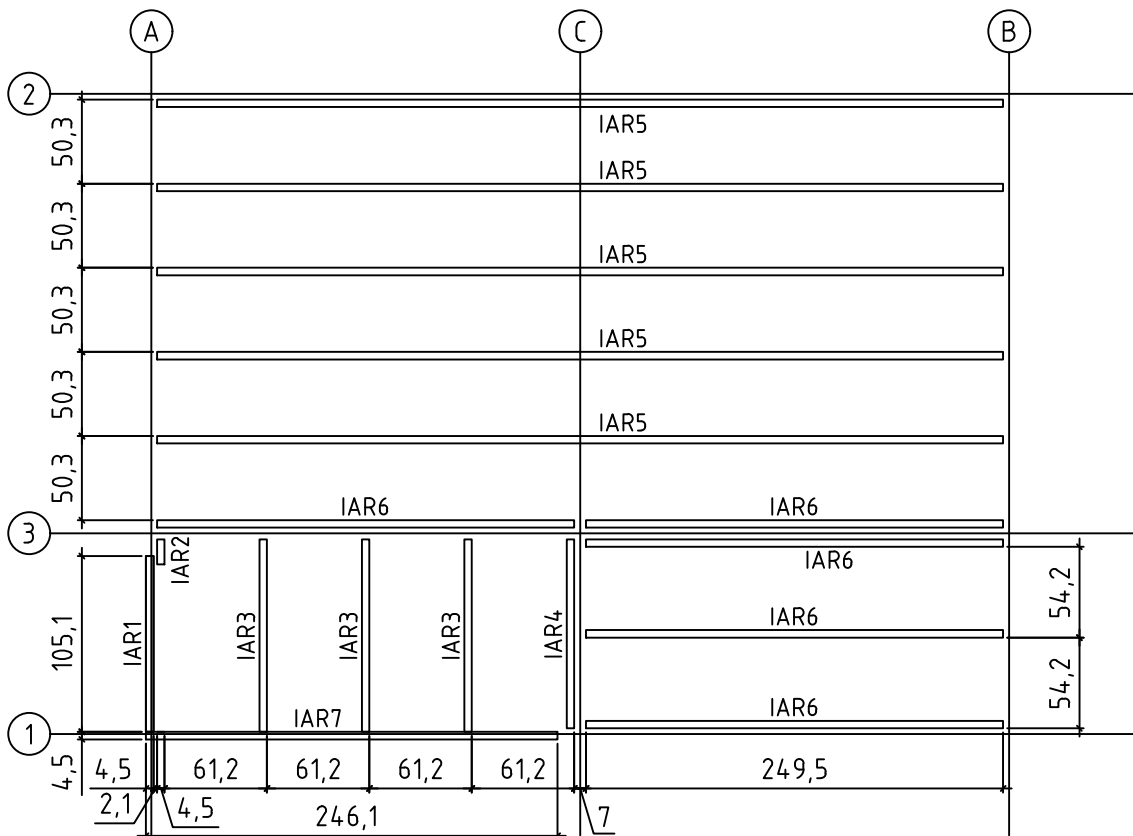

Rafters plan - Dachsparren - Plan de chevron - Piano di travi - Dak  
spar constructie plattegrond - Sarikaplaan

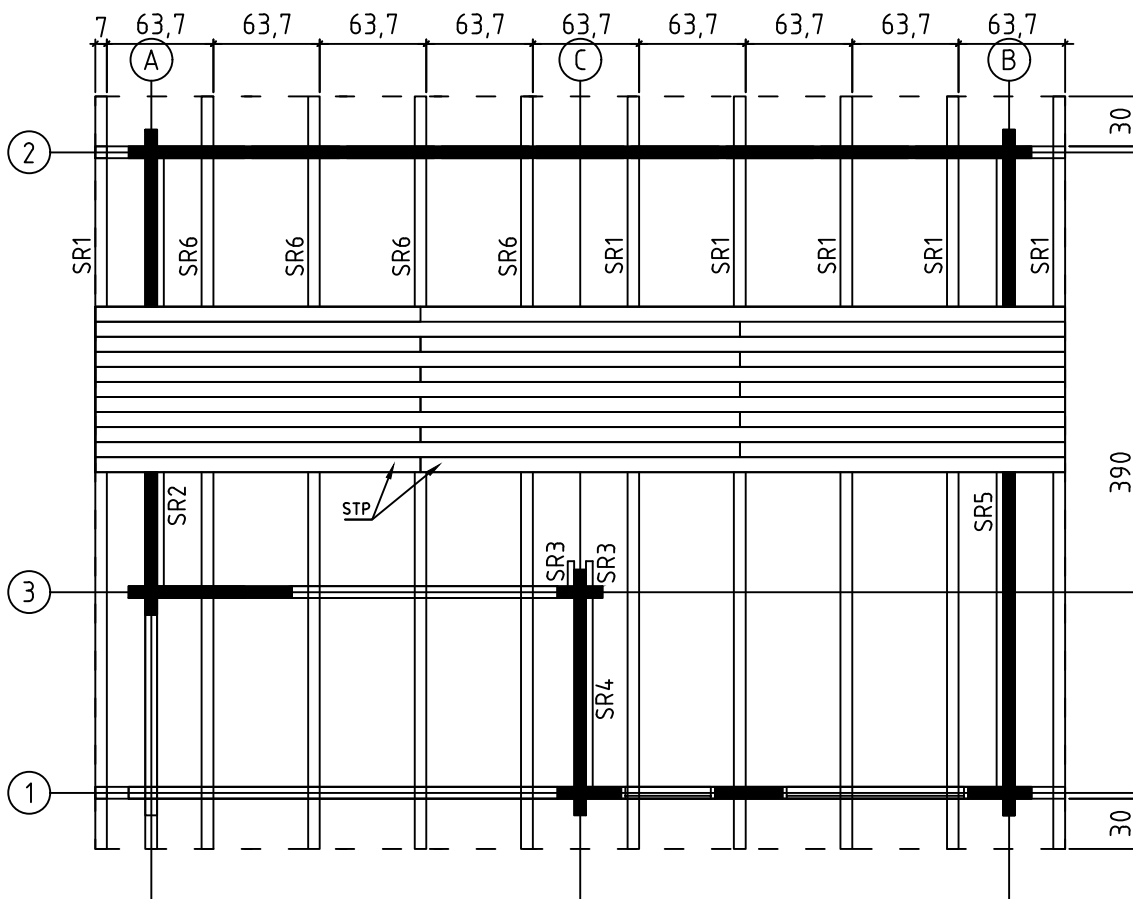

Ceiling boards - Deckenbrett - Voliges sous plafond -  
Tavole per piano soffitto - Dakhout - Laelaud

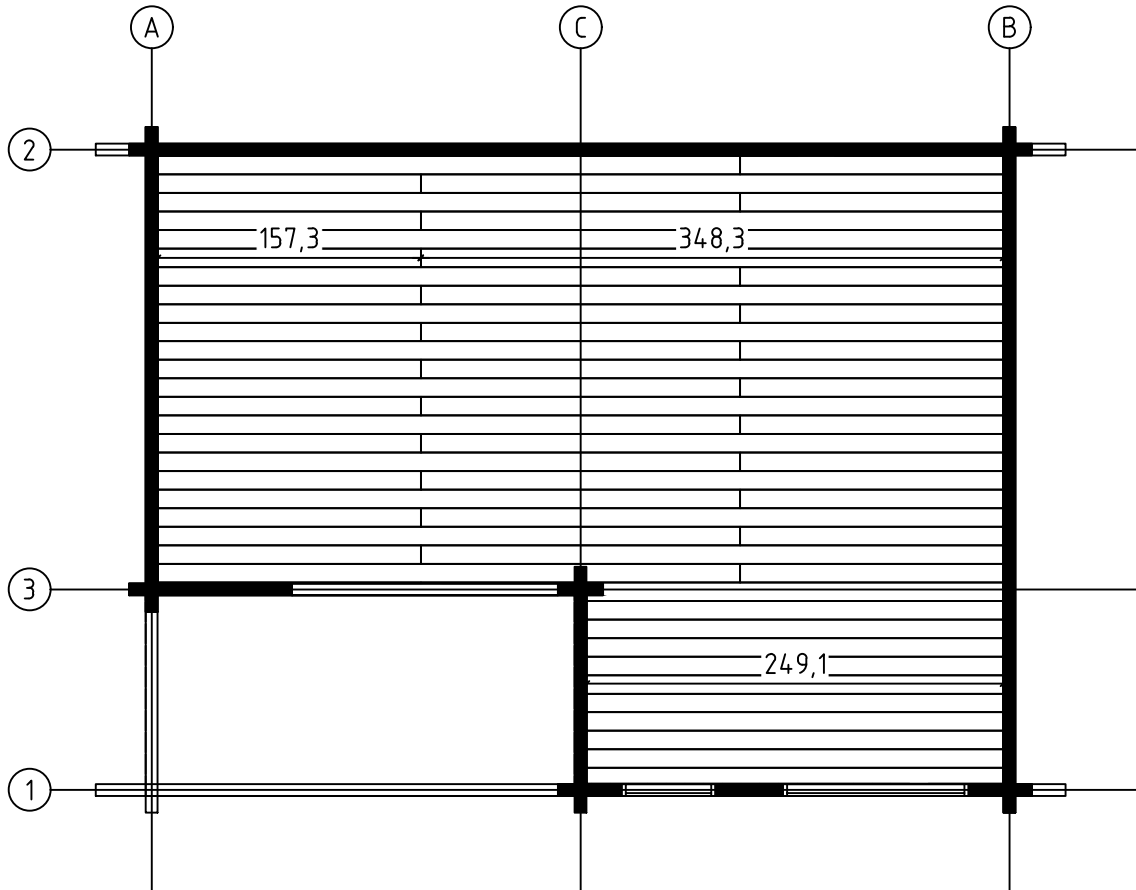

Floor boards - Fussbodenbretter - Plan pose plancher -  
Pavimento - Vloerhout - Põrandalaudis

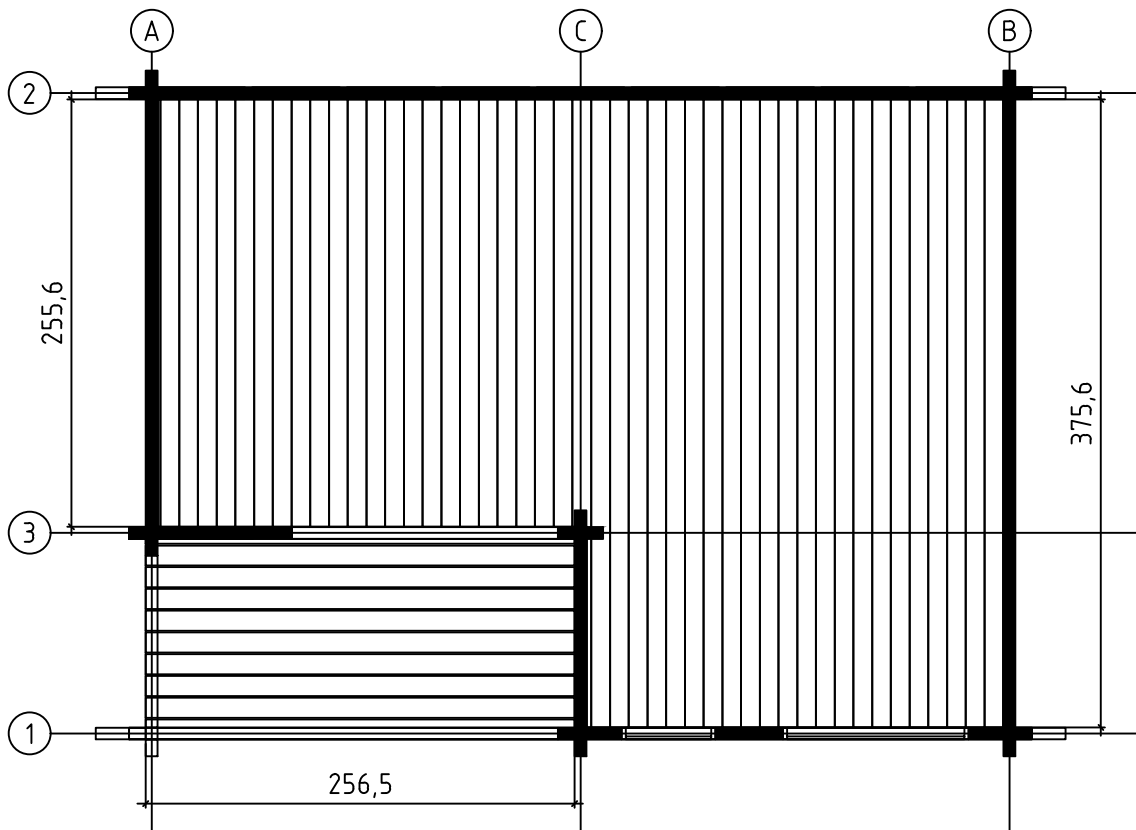





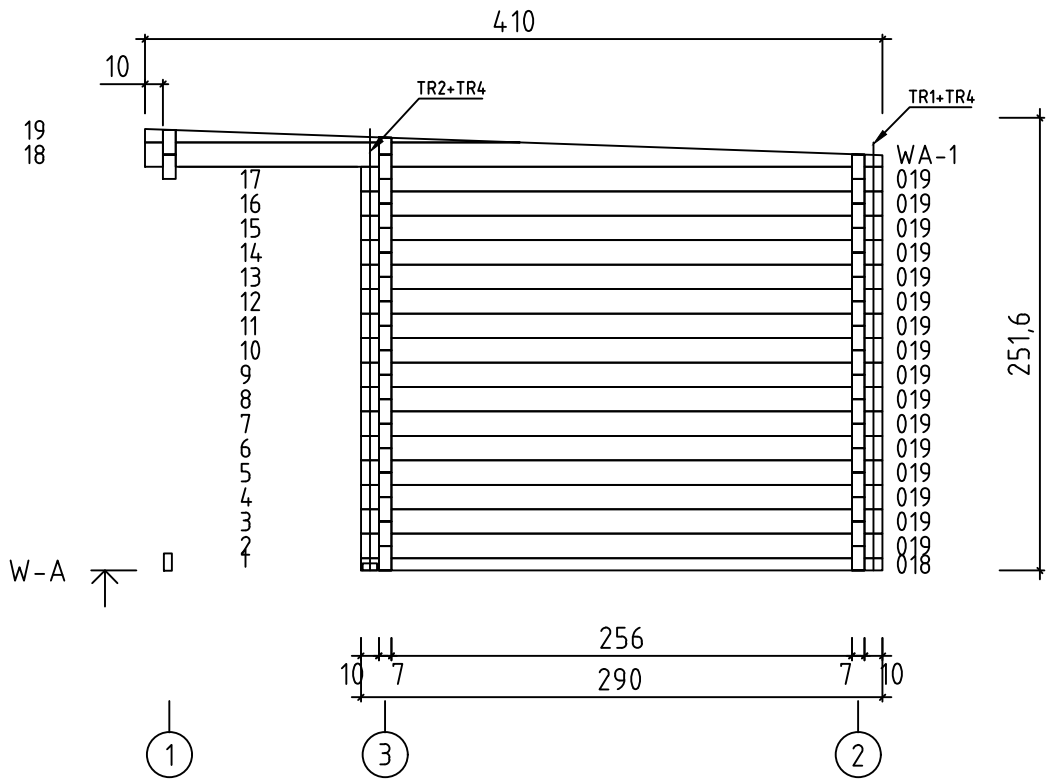
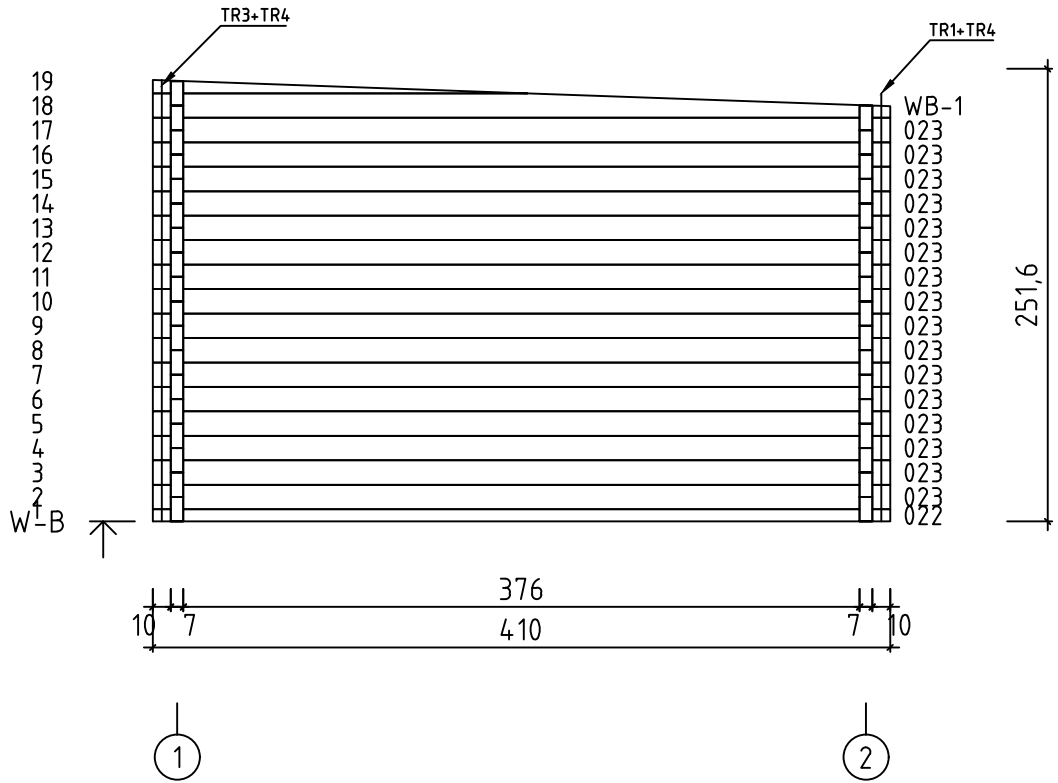

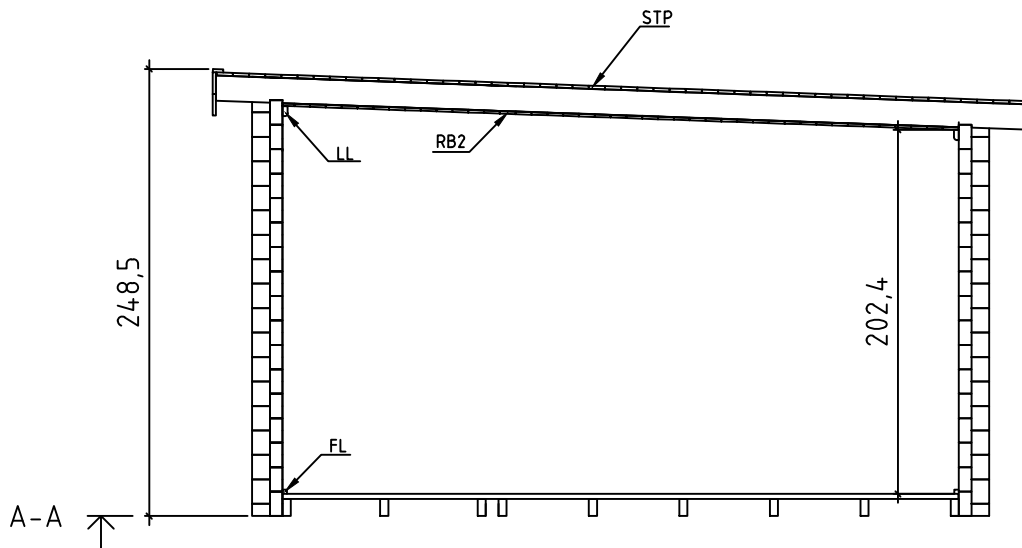
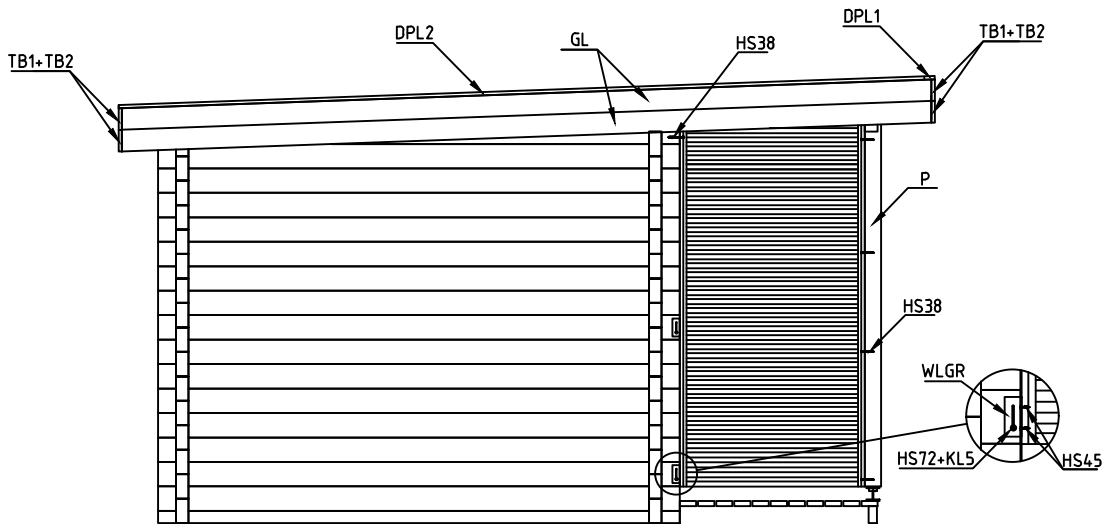
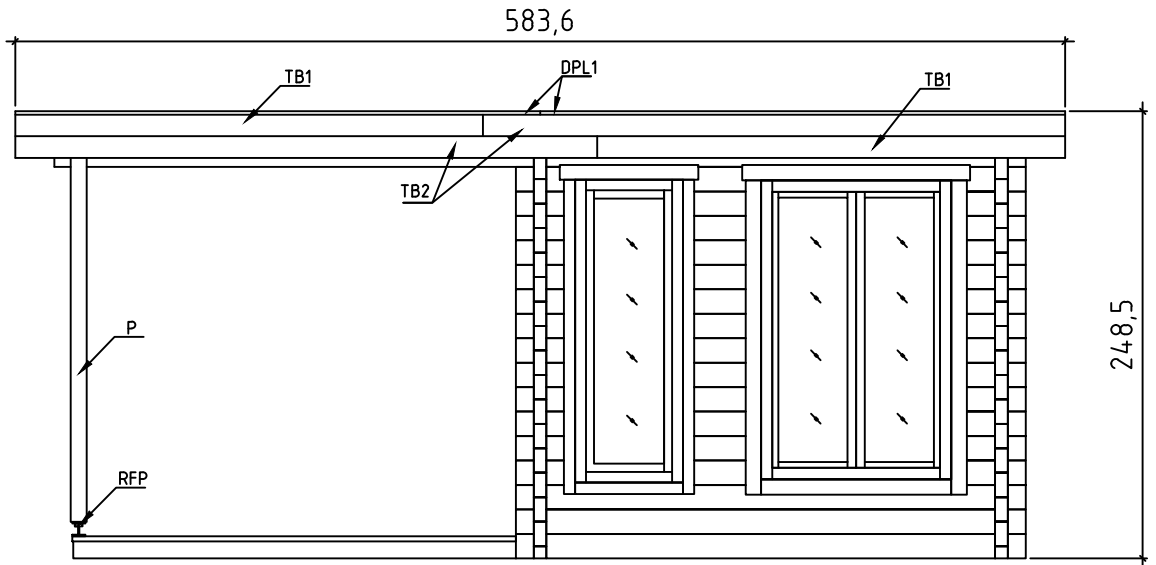



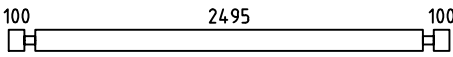

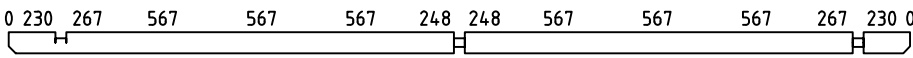
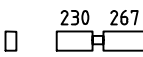
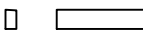
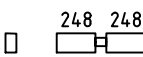
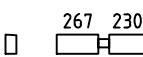
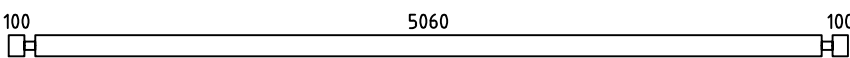
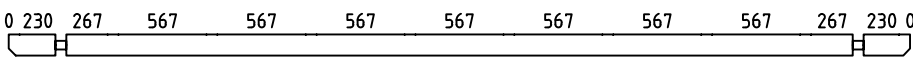
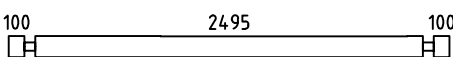
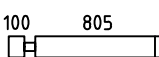

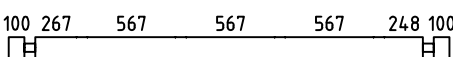
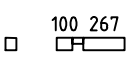
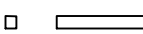
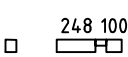
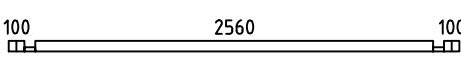
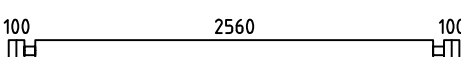
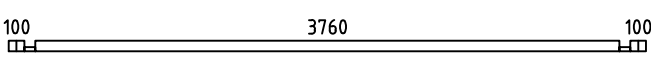
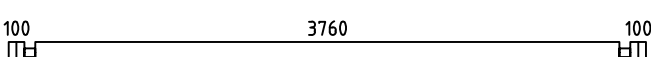
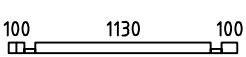
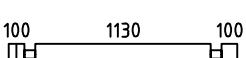

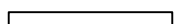
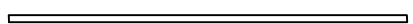

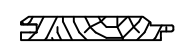



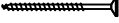
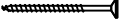
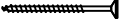
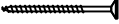
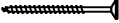
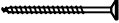
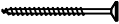
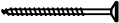
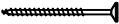
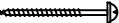

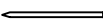

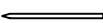
Pos	704142 - Orkney 1 Piece list - Stückliste - Liste des pièces - Elementi - Stuklijst - Tükítabel	Q	P (mm)	L (mm)
001		3	70x136	2835
002		26	70x136	380
003		13	70x136	403
004		1	70x136	5800
005		2	70x123	567
006		13	70x123	567
007		1	70x123	567
008		2	70x123	567
009		15	70x136	5400
010		1	70x136	5800
011		1	70x136	2835
012		15	70x136	975
013		15	70x136	270
014		1	70x136	2835
015		1	70x81	437
016		3	70x81	567
017		1	70x81	418
018		1	70x68	2900
019		16	70x136	2900
022		1	70x68	4100
023		16	70x136	4100
026		1	70x68	1470
027		17	70x136	1470

Pos	704142 - Orkney 1 Piece list - Stückliste - Liste des pièces - Elementi - Stuklijst - Tükítabel	Q	P (mm)	L (mm)
028		1	70x59	1470
WA-1		1		
WB-1		1		
IAR5	Foundation - Fundament - Fondation - Fondamenta - Fundering - Immutatud alusraam 	5	45x96	5060
IAR6	Foundation - Fundament - Fondation - Fondamenta - Fundering - Immutatud alusraam 	5	45x96	2495
IAR7	Foundation - Fundament - Fondation - Fondamenta - Fundering - Immutatud alusraam 	1	45x96	2461
IAR3	Foundation - Fundament - Fondation - Fondamenta - Fundering - Immutatud alusraam 	3	45x96	1151
IAR4	Foundation - Fundament - Fondation - Fondamenta - Fundering - Immutatud alusraam 	1	45x96	1130
IAR1	Foundation - Fundament - Fondation - Fondamenta - Fundering - Immutatud alusraam 	1	45x96	1051
IAR2	Foundation - Fundament - Fondation - Fondamenta - Fundering - Immutatud alusraam 	1	45x96	150
SR1	Rafter - Dachsparren - Chevron - Trave - Dak spar - Sarikas 	6	70x140	4508
SR6	Rafter - Dachsparren - Chevron - Trave - Dak spar - Sarikas 	4	70x140	4508
SR5	Rafter - Dachsparren - Chevron - Trave - Dak spar - Sarikas 	1	45x45	3764
SR2	Rafter - Dachsparren - Chevron - Trave - Dak spar - Sarikas 	1	45x45	2563
SR4	Rafter - Dachsparren - Chevron - Trave - Dak spar - Sarikas 	1	45x45	1132
SR3	Rafter - Dachsparren - Chevron - Trave - Dak spar - Sarikas 	2	45x45	152
RB1	Ceiling boards - Deckenbrett - Voliges sous plafond - Tavole per piano soffitto - Dakhout - Laelaud 	24	111x15	3483
RB2	Ceiling boards - Deckenbrett - Voliges sous plafond - Tavole per piano soffitto - Dakhout - Laelaud 	10	111x15	2491
RB3	Ceiling boards - Deckenbrett - Voliges sous plafond - Tavole per piano soffitto - Dakhout - Laelaud 	24	111x15	1573
PTL	Floor boards - Fussbodenbretter - Lamé de plancher - Pavimento - Vloerhout - Põrandalaud 	23	112x28	3756
PTL	Floor boards - Fussbodenbretter - Lamé de plancher - Pavimento - Vloerhout - Põrandalaud 	23	112x28	2556
STP	Roof boards - Dachbretter - Voliges - Perlina per tetto - Dakhout - Katuselaud 	51	90x18	3855
STP	Roof boards - Dachbretter - Voliges - Perlina per tetto - Dakhout - Katuselaud 	51	90x18	1945

Pos	704142 - Orkney 1 Piece list - Stückliste - Liste des pièces - Elementi - Stuklijst - Tükítabel	Q	P (mm)	L (mm)
	Terrace boards - Terrassenbretter - Plancher de terrasse - Piattaforme terrazzo - Terrasvloer - Terrassilaud 	10	120x28	2565
FL	Floor fillet - Fussbodenteiste - Corniere de finition du plancher - Finitura per pavimento (battisco pa) - Vloerafwerkljst - Pörandaliist 		18x18	17.62 j.m.
LL	Ceiling fillet - Deckeleiste - Profil de finition sous plafond - Massello per soffitto - Dak afdeklijst - Laeliist 		13x40	17.63 j.m.
DPL1	Roofing felt fillet - Dachpappenleiste - Baguette de fixation du feutre bitumeux - Asse per fissaggio guaina bituminosa - Afdeklijst asfaltpapier - Katusepapiiist 	2	18x58	2919
DPL2	Roofing felt fillet - Dachpappenleiste - Baguette de fixation du feutre bitumeux - Asse per fissaggio guaina bituminosa - Afdeklijst asfaltpapier - Katusepapiiist 	2	18x58	4481
TR1	Treaded rod m12 - Gewindestange m12 - Tige filetée m12 - Barra filettata passo m12 - Draadstang 12m - Keermelatt 	2		325
TR2	Treaded rod m12 - Gewindestange m12 - Tige filetée m12 - Barra filettata passo m12 - Draadstang 12m - Keermelatt 	1		384
TR3	Treaded rod m12 - Gewindestange m12 - Tige filetée m12 - Barra filettata passo m12 - Draadstang 12m - Keermelatt 	2		467
TR4	Treaded rod m12 - Gewindestange m12 - Tige filetée m12 - Barra filettata passo m12 - Draadstang 12m - Keermelatt 	5		2000
P	Post - Pfosten - Poteau - Piede registrabile - Stijl - Post 	1	90x90	2040
TB1	Fascia board - Traufbrett - Bandeau de toit - Finitura lati tetto - Gevellijst - Räästalaud 	4	18x120	2600
TB2	Fascia board - Traufbrett - Bandeau de toit - Finitura lati tetto - Gevellijst - Räästalaud 	4	18x120	3236
TBE6	Fixing fillet - Fixirungsleiste - Profil de fixation - Massello di fissaggio - Bevestiging lijstwerk - Tenderliist 	4	28x34	1729
TBE6	Fixing fillet - Fixirungsleiste - Profil de fixation - Massello di fissaggio - Bevestiging lijstwerk - Tenderliist 	2	28x34	2000
GL	Gable moulding - Giebelleiste - Planche de rive - Finitura per frontale e retro del tetto - Gevellijst - Viilulaud 	4	18x120	4504
KL4	Lengthening bolt for treaded rod - Verlängerungsmutter für gewindestange - Manchon de raccordement de tige filetée - Bullone per barra filettata passo - Extensie moer voor draadstang - Jätkumutter keermelatile 	5		
KL1	Drive nut treaded rod - Einschlagmutter für gewindestange - Écrou a frapper pour tige filitée - Dado guida per barra filettata - Aandrijfmoer / aanslagmoer voor draadstang - Löökmutter keermelatile 	5		
KL2	Nut for treaded rod - Mutter für gewindestange - Écrou pour tige filetée - Dado per barra filettata - Moer voor draadstang - Mutter keermelatile 	5		
KL3	Plain washer treaded rod - Unterlegscheibe für gewindestange - Rondelle plate pour tige filetée - Rondella per barra filettata - Sluistring voor draadeind - Seib keermelatile 	5		
HS32	Screw for fascia boards - Schrauben für traufbretter - Vis pour fixation bandeau de toit - Viti x striscia del tetto - Schroef voor gevellijst - Kruvi räästalauale 	88	3.5x50	
HS84	Screw for fixing fillet of door and window - Schrauben für fixirungsleiste - Vis pour profil vertical de fixation pour ouvertures des fenetres et portes - Viti per massello di fissaggio - Schroeven voor bevestiging van deur en raam lijsten - Kruvi tenderliistudele 	30	3.5x50	
HS16	Screw for gable moulding - Schrauben für giebelleiste - Vis pour fixation planche de rive - Vite per fissare finiture davanti e dietro del tetto - Schroef voor gevellijst - Kruvi viilulauale 	44	3.5x50	
HS38	Screw for fixing terrace railing - Schraube für terrasse - Vis de fixation de garde-corps de terrasse - Vite per fissaggio della ringhiera al terrazzo - Schroef voor terras - Kruvi piirdeaia kinnifuseks 	5	4.5x80	

Pos	704142 - Orkney 1 Piece list - Stückliste - Liste des pièces - Elementi - Stuklijst - Tükítabel	Q	P (mm)	L (mm)
HS37	Screw for post - Schrauben für pfosten - Vis de fixation des poteaux - Viti per inviare - Schroef voor stijlen - Krugi postile 	2	4.5x80	
HS45	Screw for sliding wall tie - Schieberegler für wand - Sabot métallique pour fixation mur - Vite per fissare scorrimento a c su slitta fissata alla parete - Schuifdeur instellingen wand - Krugi seinaliugurite 	8	4x20	
NFD	Screw for roofing felt fillet - Schrauben für dachpappenleiste - Vis pour fixation baguette de fixation feutre bitumeux - Vite per massellino del feltro del tetto - Schroef voor asfaltpaier afdekljst - Krugi katusepapiliistule 	34	4x40	
HS43	Screw for roof beams - Schrauben für dachbalken - Vis pour fixation pannes de toit - Viti per perline del tetto - Schroef voor gordingen / dakbalken - Krugi pärlinitele 	24	5x120	
	Screw for gable - Schrauben für giebel - Vis pour fixation des pignons - Viti per timpano - Schroef voor gevelpunt - Krugi viilude kinnitamiseks 	8	5x120	
HS39	Screw for foundation - Schrauben zur befestigung fundament - Vis de fixations des poutrelles de fondations - Viti x fundamenta - Schroef voor fundering - Krugi alusraamite 	39	5x90	
HS81	Screw for ceiling board holder - Schraube für halter für deckengbretter halter - Vis de fixation support pour panneaux de plafond - La vite per il listello di fissare il tavolo del soffitto - Schroef voor bevestiging aan de plafondplaat - Krugi laelaua kinnitusliistule 	26	5x90	
HS48	Screw for pos.005-008; 015-017 - Schrauben für pos.005-008; 015-017 - Vis pour pos.005-008; 015-017 - Viti per fissare elemento vedi figura in pos.n.005-008; 015-017 - Schroef voor pos.005-008; 015-017 - Krugi pos.005-008; 015-017 	46	6x180	
HS49	Screw for post height adjustment - Schrauben für regulierungsschraube für pfosten - Vis de fixation de support réglable de poteau - Viti per fissare ed aggiustare l'altezza del palo verticale - Schroef voor hoogte instelling stijlen - Krugi vajumispolidite 	8	6x50	
HS72	Screw for sliding wall tie - Schieberegler für wand - Sabot métallique pour fixation mur - Vite per fissare scorrimento a c su slitta fissata alla parete - Schuifdeur instellingen wand - Krugi seinaliugurite 	2	5x60	
SH70	Hammer block - Schlagholz - Calle de frappe - Blocco di legno da usare come cuscinetto quando si usa il martello - Slagklos - Löögiklots 	2		
MS	Screw for doorstep - Schrauben für swelle - Vis pour fixation barre de seuil - Vite per soglia della porta - Schroef voor deurdorpel - Krugi lävepakule 	3	4.5x65	
NF3	Zn nail for terrace - Zn nägel für terrassenbretter - Pointe pour plancher de terrasse - Chiodo zincato per terrazza - Spijker(nagel) voor terrasvloer - Nael terrassilauale 	95	2.1x50	
	Zn nail for ceiling fillet - Zn nägel deckeleiste - Pointe pour profil de finition sous plafond - Chiodi zincati per massellini del soffitto - Spijker(nagel) voor plafond afdekljst - Nael laeliistule 	35	1.4x40	
	Zn nail for floor fillet - Zn nägel für fussbodenleiste - Pointe pour corniere de finition du plancher - Chiodi x fissaggio pavimento - Spijker(nagel) voor vloer afdekljst - Nael põrandaliistule 	35	1.4x40	
NF2	Zn nail for roof - Zn nägel für dachbretter - Pointe pour fixation voliges de toit - Chiodi x perline tetto - Spijker(nagel) voor dakhout - Nael katuselauale 	645	2.1x50	
NF2	Zn nail for ceiling boards - Zn nägel für deckenbretter - Clous pour voliges sous plafonds - Chiodo per il tavolo del soffitto - Spijkers voor plafondplaat - Nael laelauale 	420	2.1x50	
NH1	Zn nail for floor - Zn nägel für fussbodenbretter - Clous pour plancher - Chiodi x perline pavimento - Spijker(nagel) voor vloer - Nael põrandalauale 	330	2.1x50	
ORZ	Montage set for doors and windows - Montage-set für türen und fenster - Jeu de montage portes et fenetres - Set di assemblaggio per porte e finestre - Montage set voor deur en raam - Orthez akna ja ukse montaaživahendid	1		
KL5	Plain washer - Unterlegscheibe - Rondelle plate - Rondella piana - Sluifring - Seib seina ja sarikaliugurite 6 mm 	2		
WLGR	Sliding wall tie - Schieberegler für wand - Sabot métallique pour fixation mur - Cravatta parete scorrevole - Schuifregelaar voor wand - Seinaliugur 	2		
RFP	Post height adjustment - Regulierungsschraube für pfosten - Support réglable de poteau - Piede registrabile in altezza - Stelschroef voor stijlpost - Vajumispolt 	1		

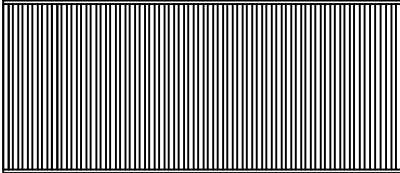
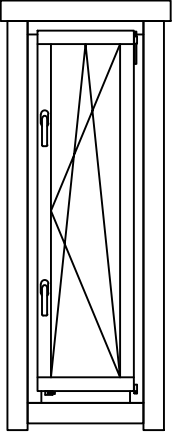
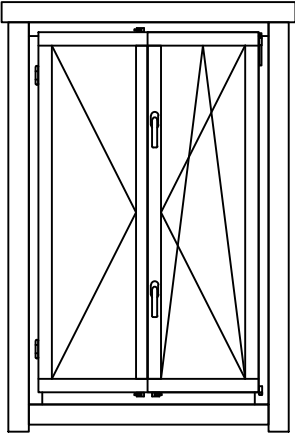
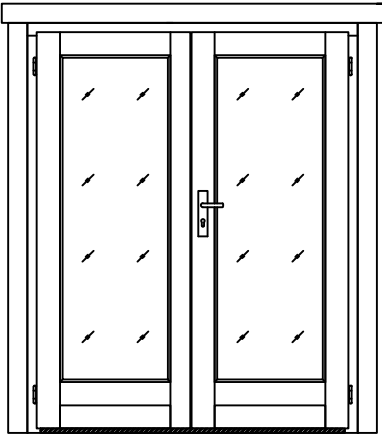
Pos	704142 - Orkney 1 Piece list - Stückliste - Liste des pièces - Elementi - Stuklijst - Tükítabel	Q	P (mm)	L (mm)
	Terrace railing - Terrassenzaun - Garde-corps de terrasse - Ringhiera per terrazza - Terras rails (leuning) - Piirdeaed kõrgusega 	1		2040
2+ A.0P.b	Window - Fenster - Fenetre - Finestra - Raam - Aken 552x1729 	1		
2+ TA.0P.b	Window - Fenster - Fenetre - Finestra - Raam - Aken 1100x1729 	1		
2+ TU.10P.b	Door - Tür - Porte - Porte - Deur - Uks 1580x2000 	1		

