

Eastleigh
Art. Nr. 2852200
1/13

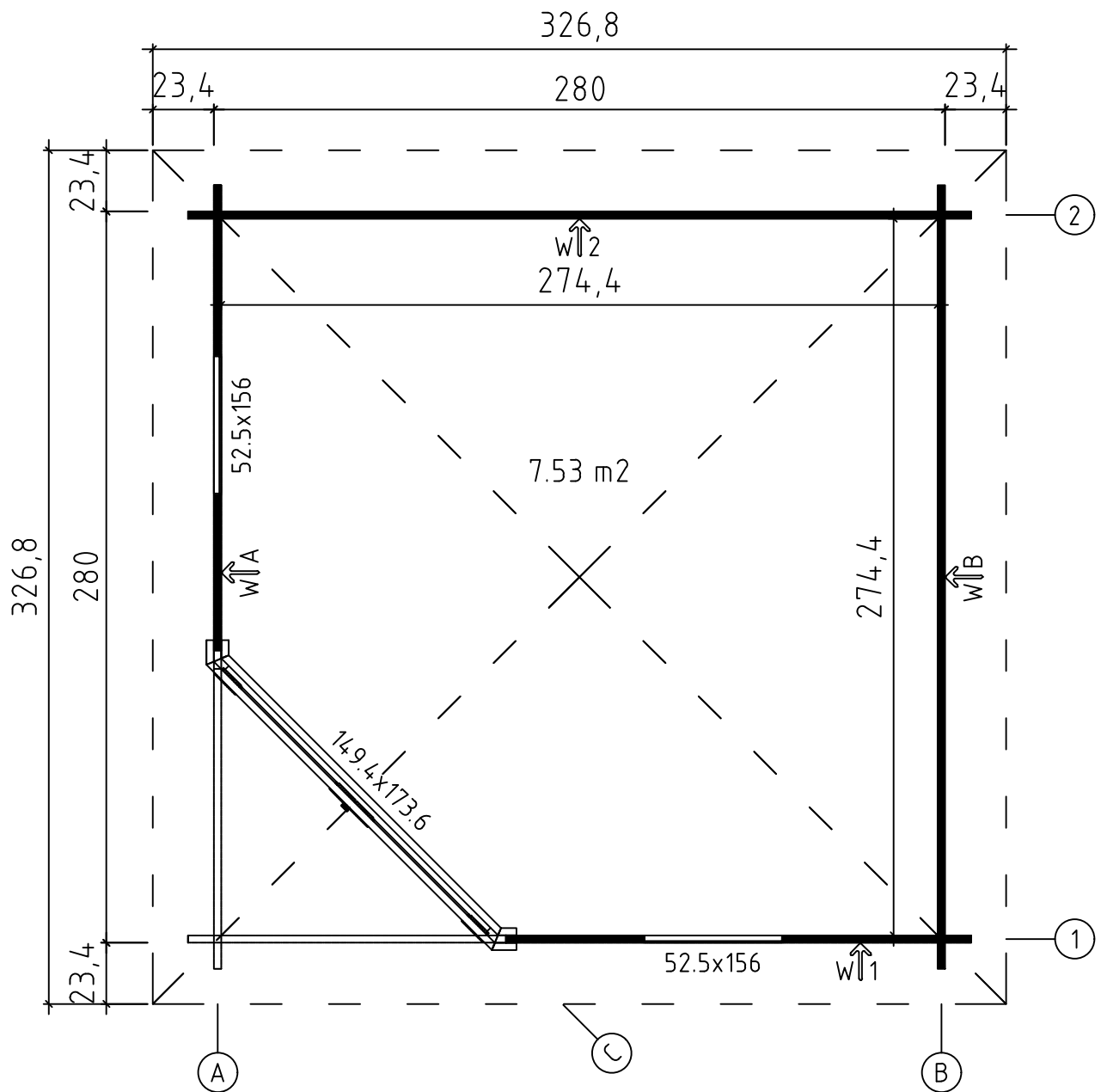

15.02.2022

Groundplan - Grundplan - Plan de masse -
Planimetria - Plattegrond - Põhiplaan



Foundation - Fundament - Fondation -
 Fundamenta - Fundering - Immutatud alusraam

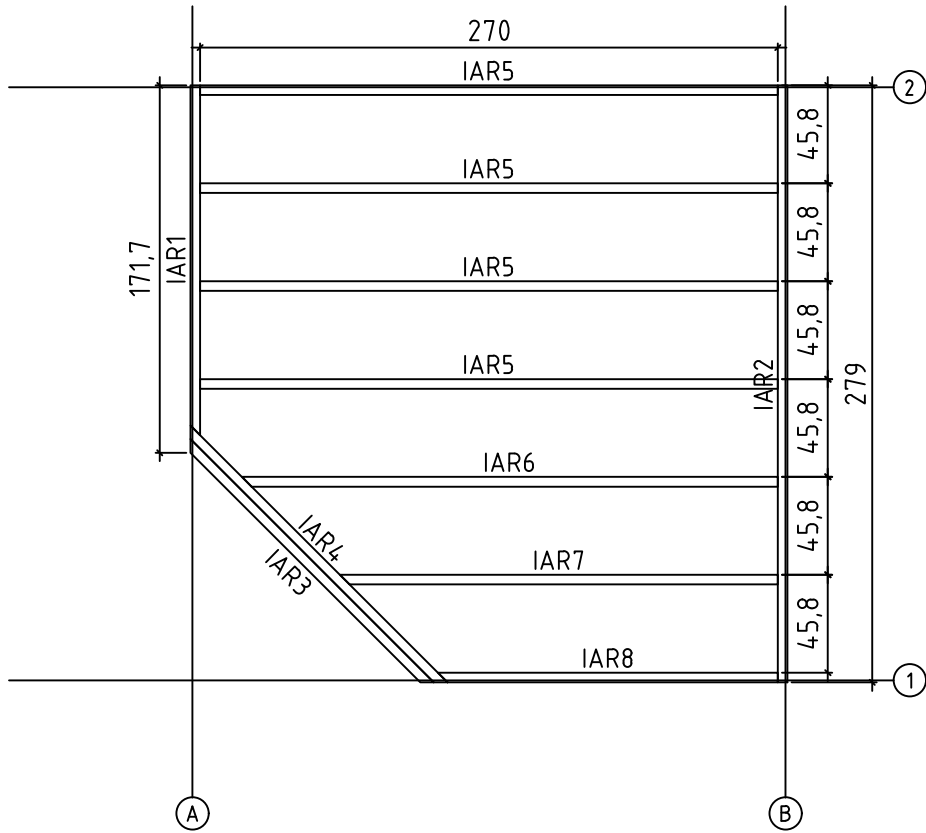

Floor boards - Fussbodenbretter - Plan pose plancher -
 Pavimento - Vloerhout - Põrandalaudis

Mounting direction -
 Aufbauschnitte -
 Instruction de montage -
 Direzione di montaggio -
 Beverstigungsrichting -
 Monteerimise suund

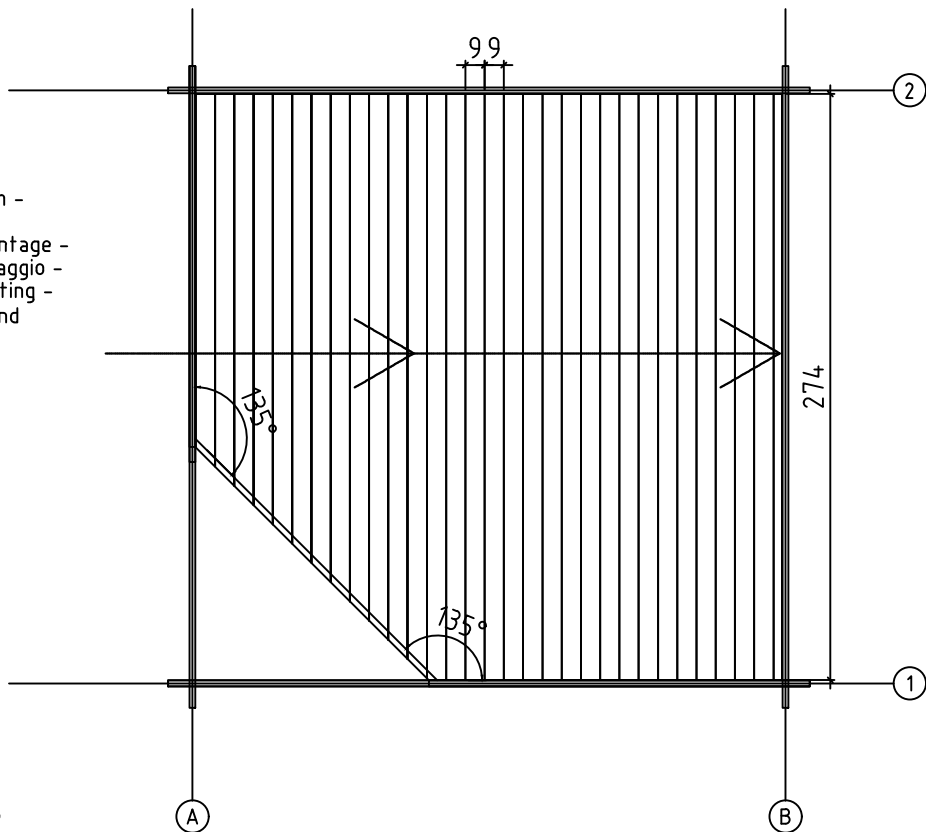

Overhead beams - Deckenbalken - Solives - Travi a vista -
Overlopende balken - Laetalade konstruktisioon

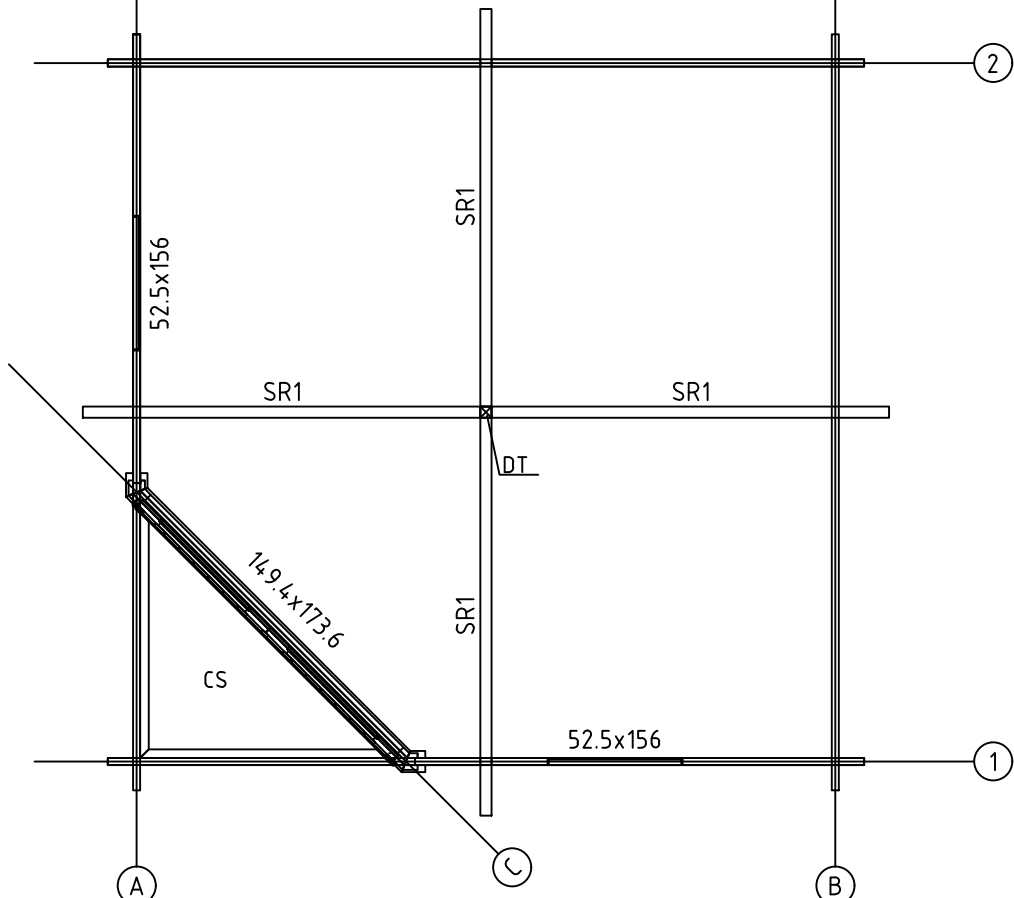

Diagonals must be equal A=B - Prüfung diagonale Austrichtung A=B -
Controle des diagonales A=B - Le diagonali devono essere eguali A=B -
Gelijkbenige diagonaal A=B - Diagonaalid peavad olema võrdsed A=B

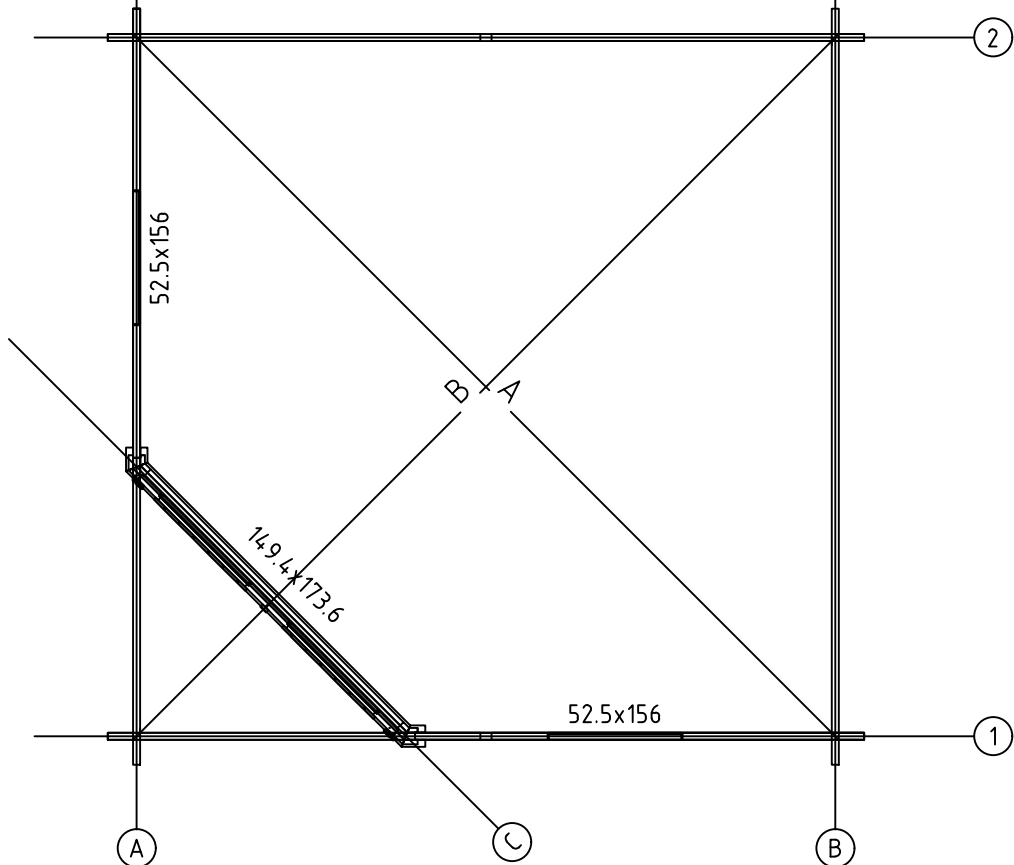

Art. Nr. 2852200

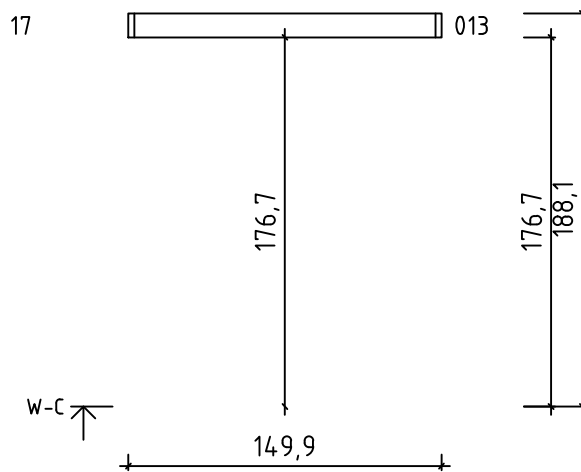
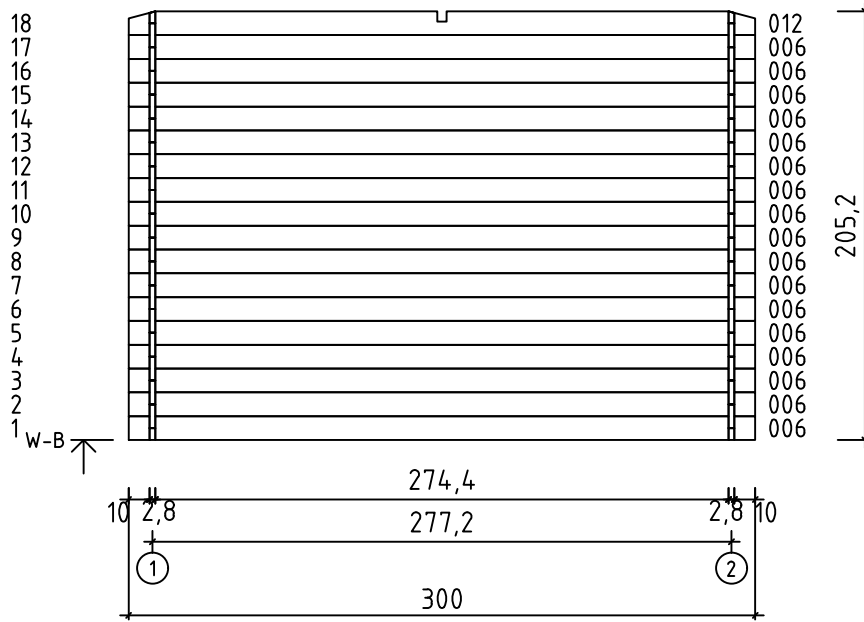
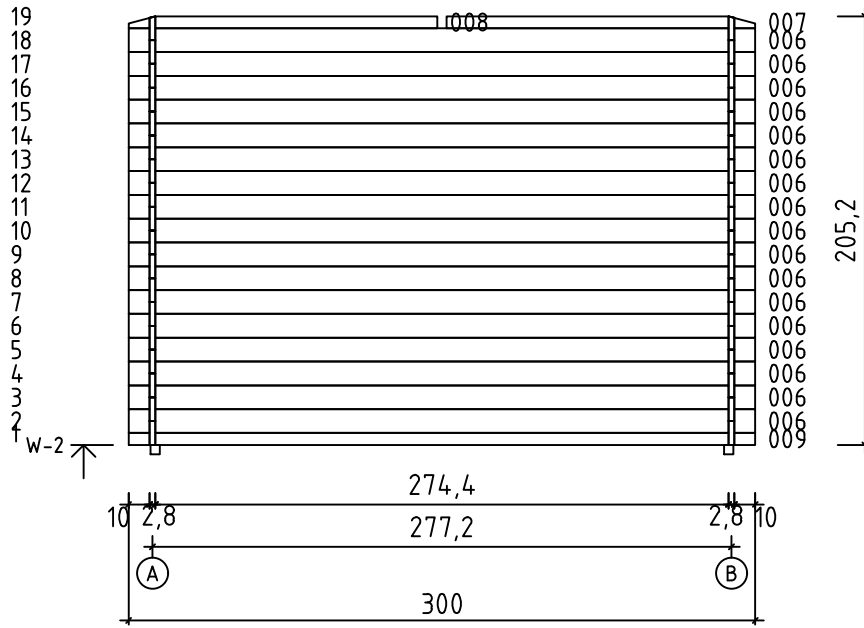

Art. Nr. 2852200

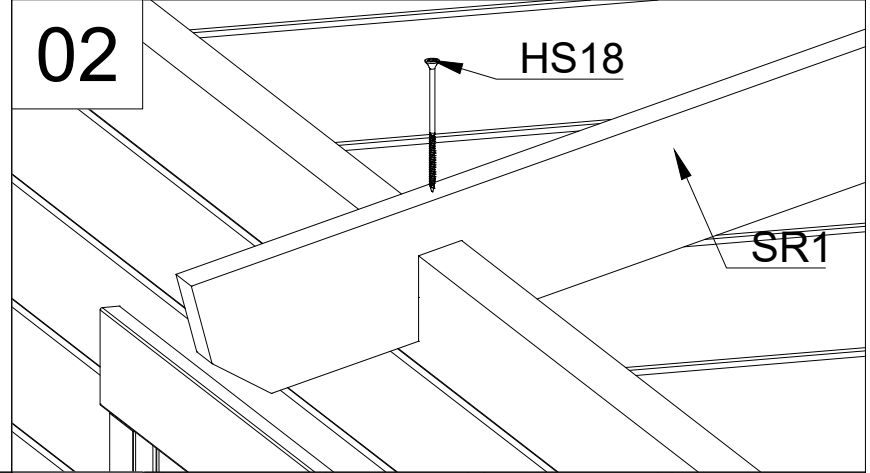
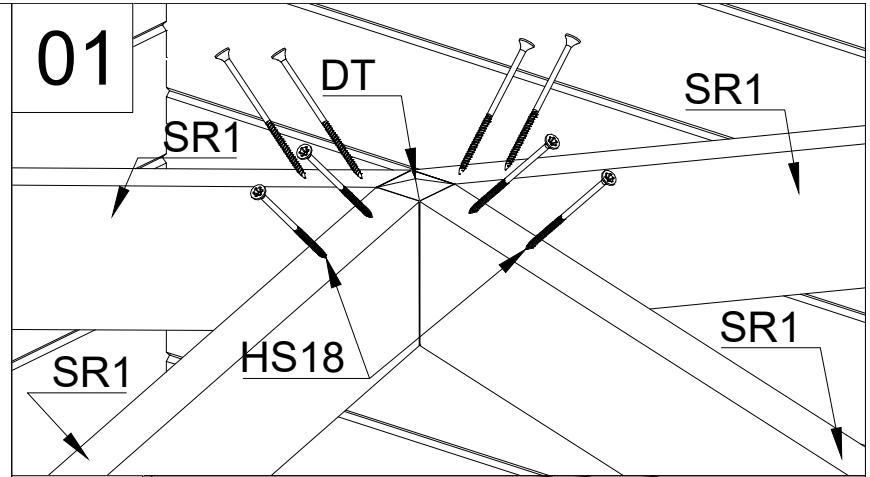
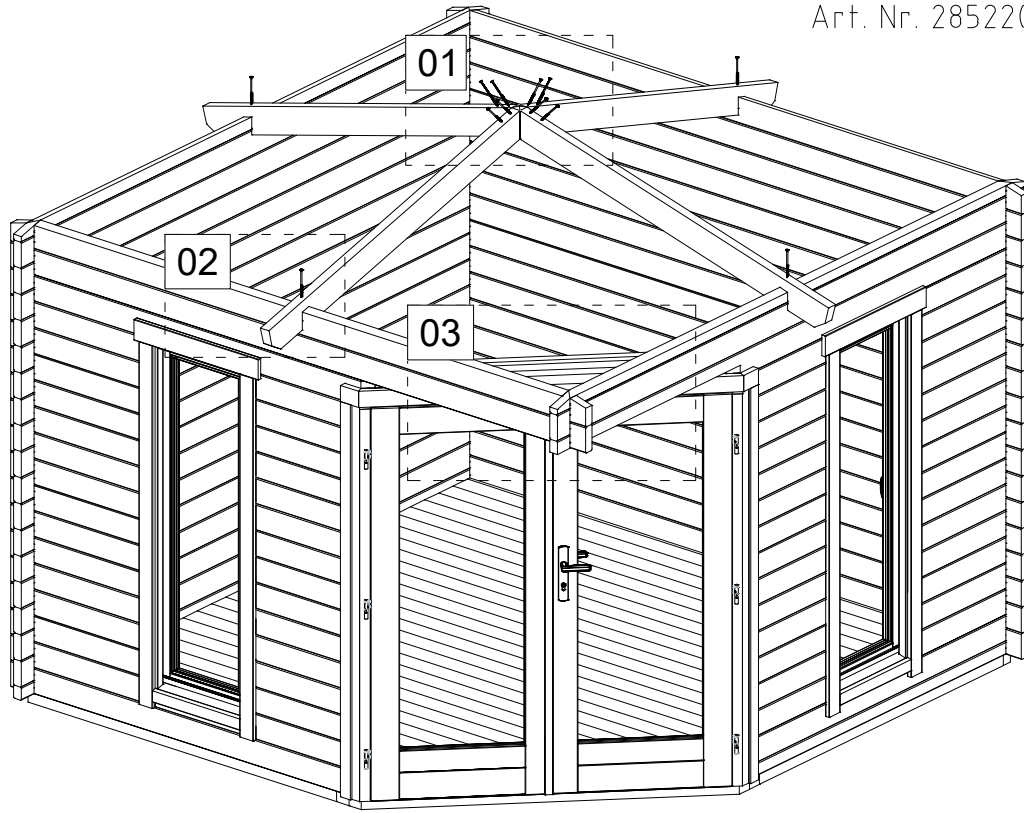

03

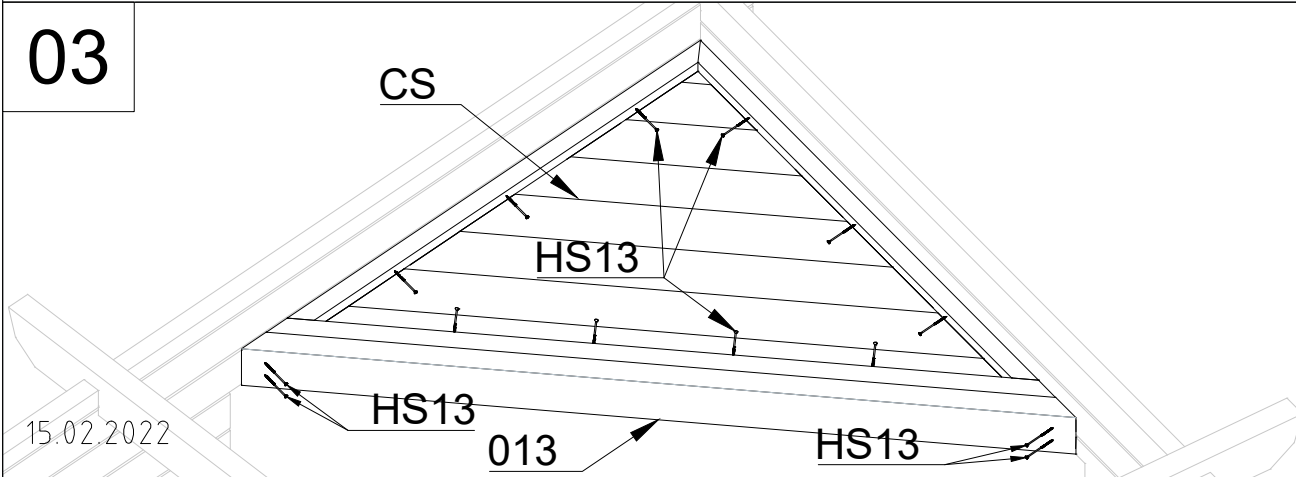

03

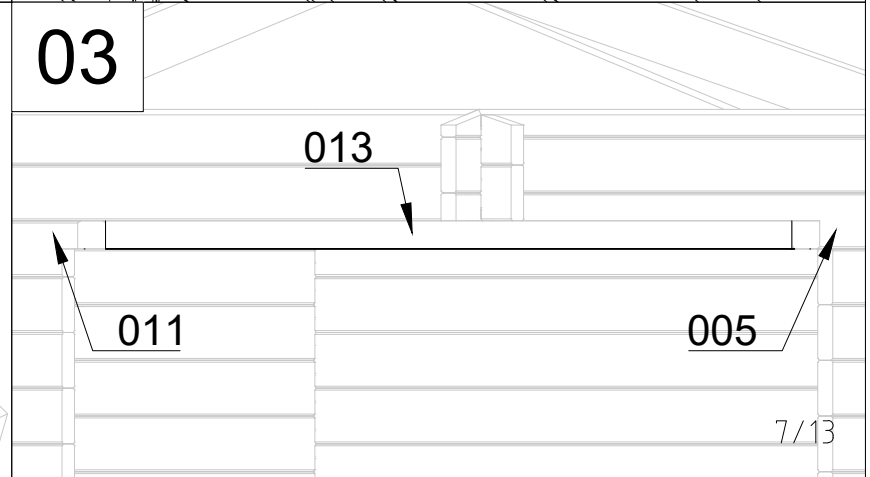

15.02.2022

7/13

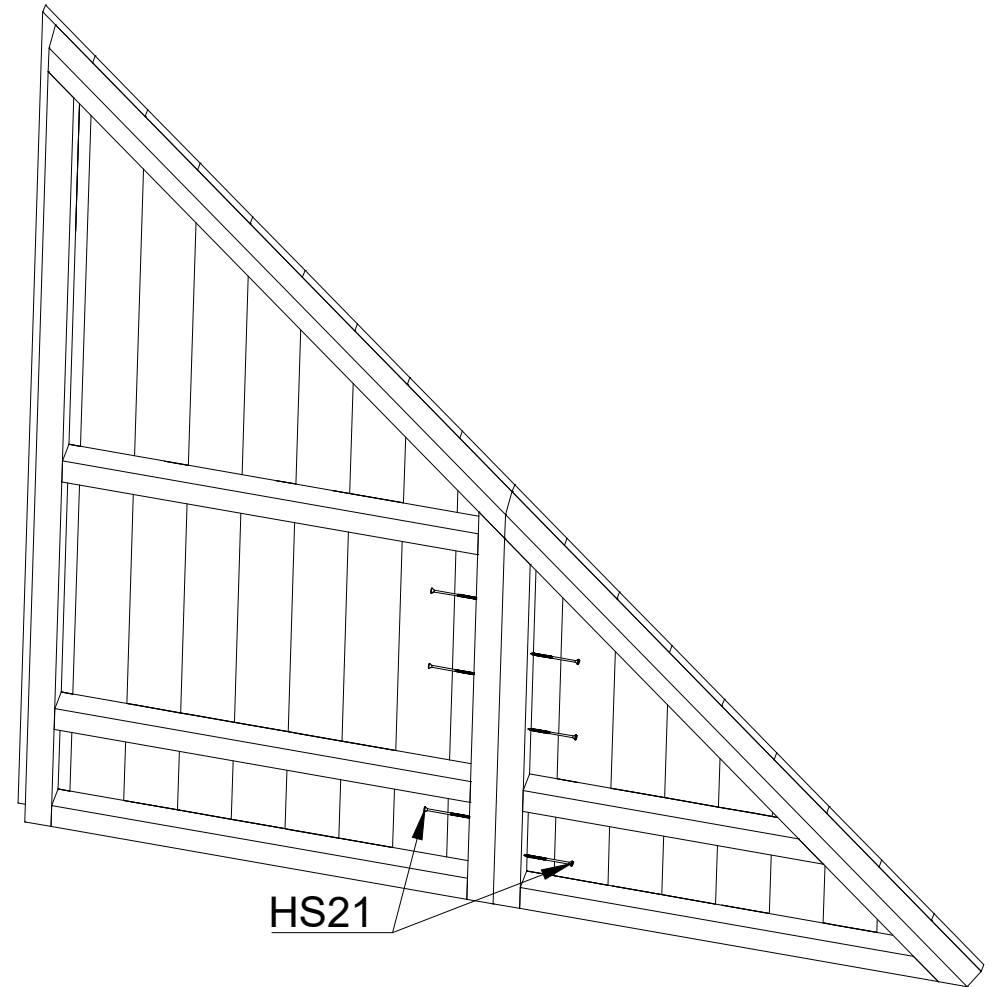
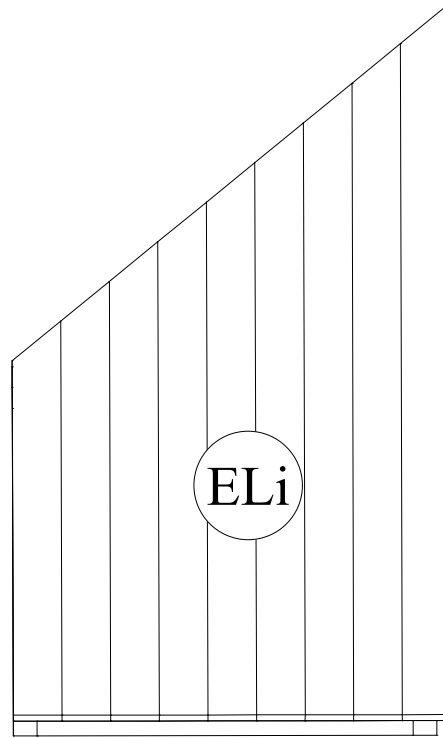
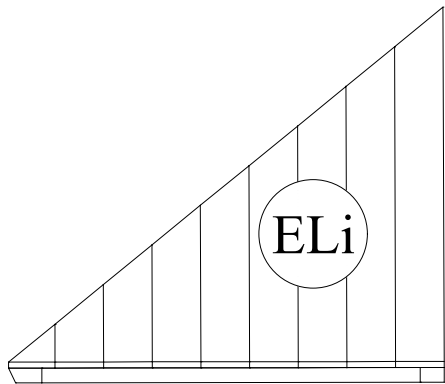

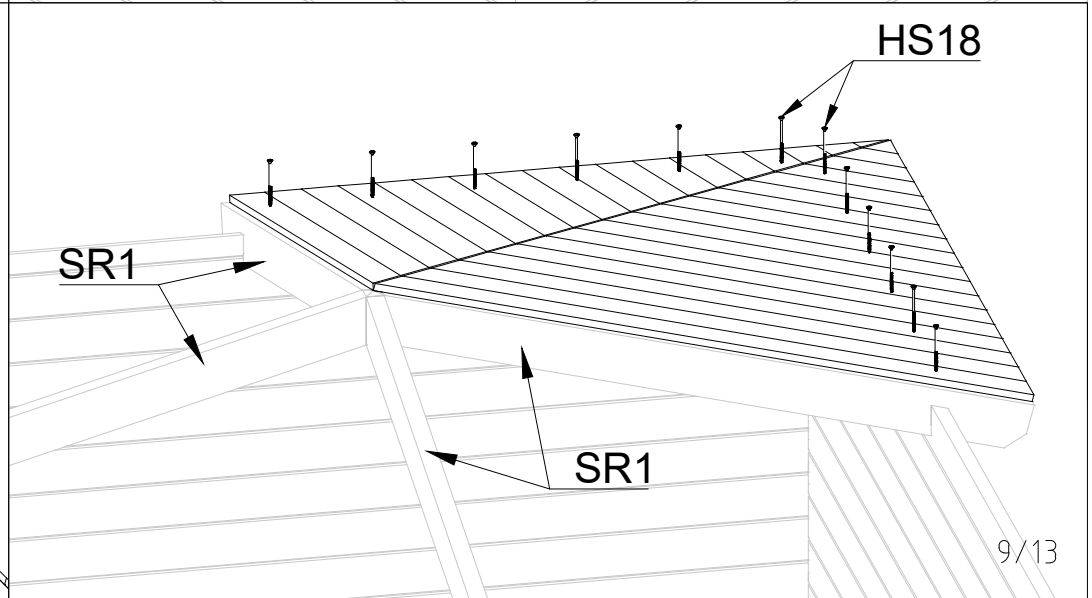
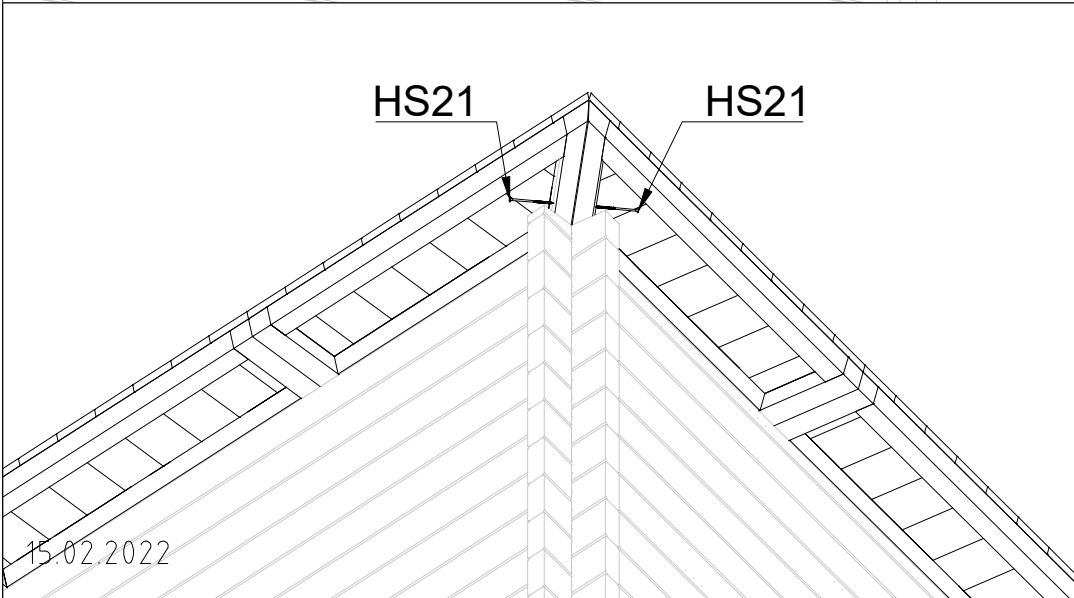
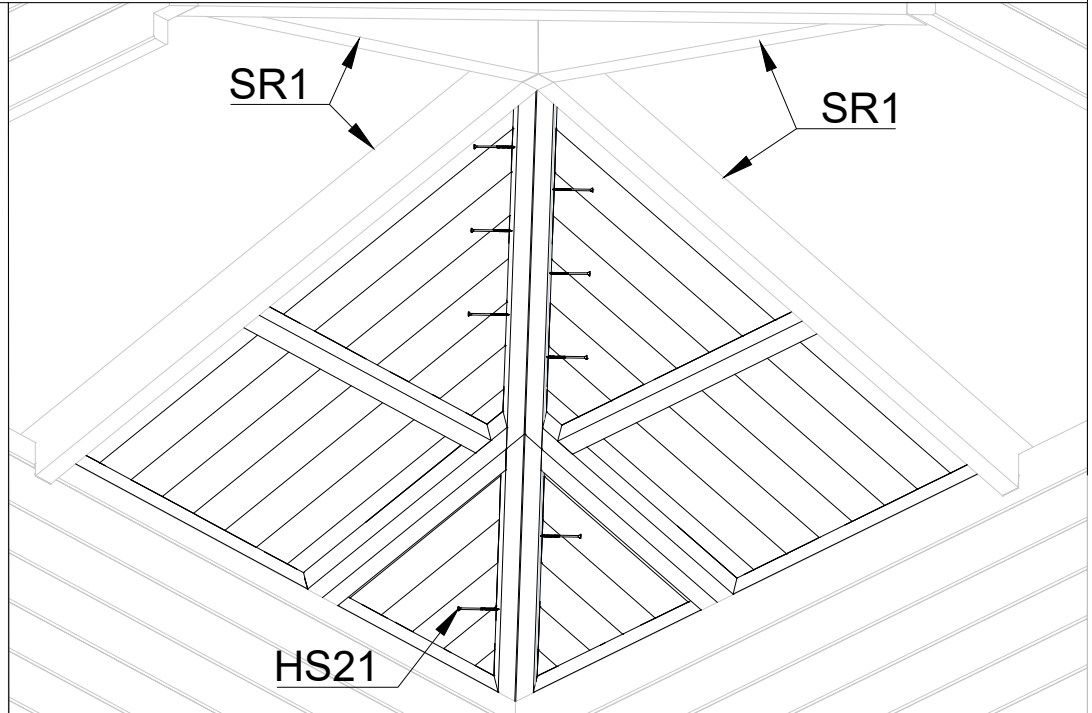
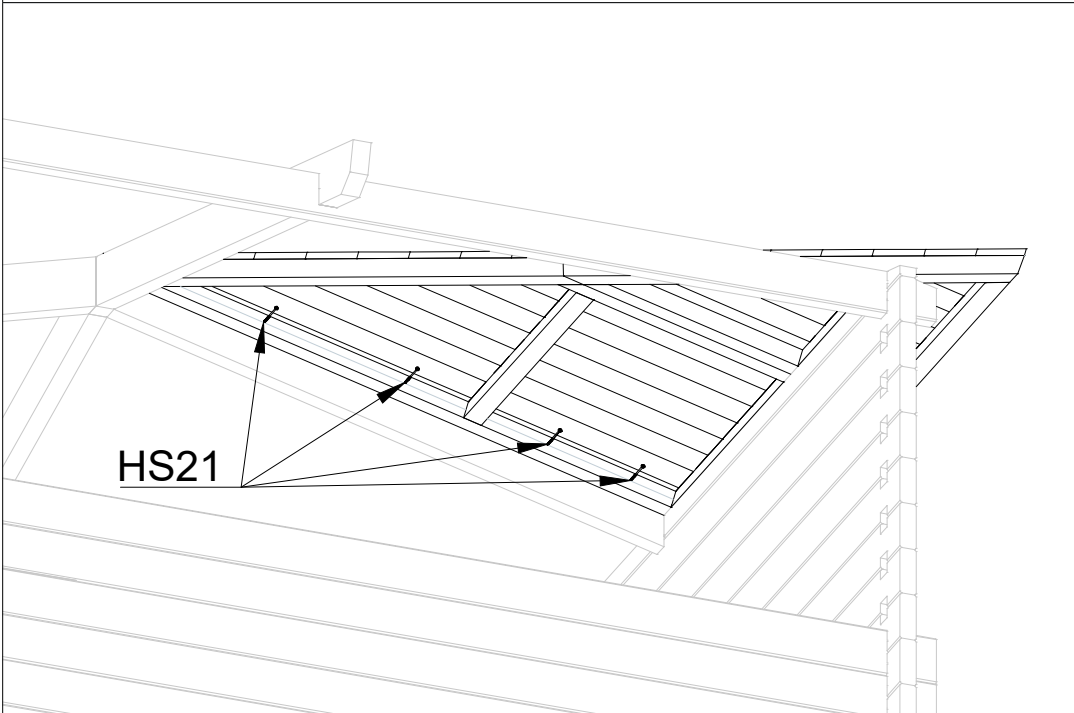

Art. Nr. 2852200

1

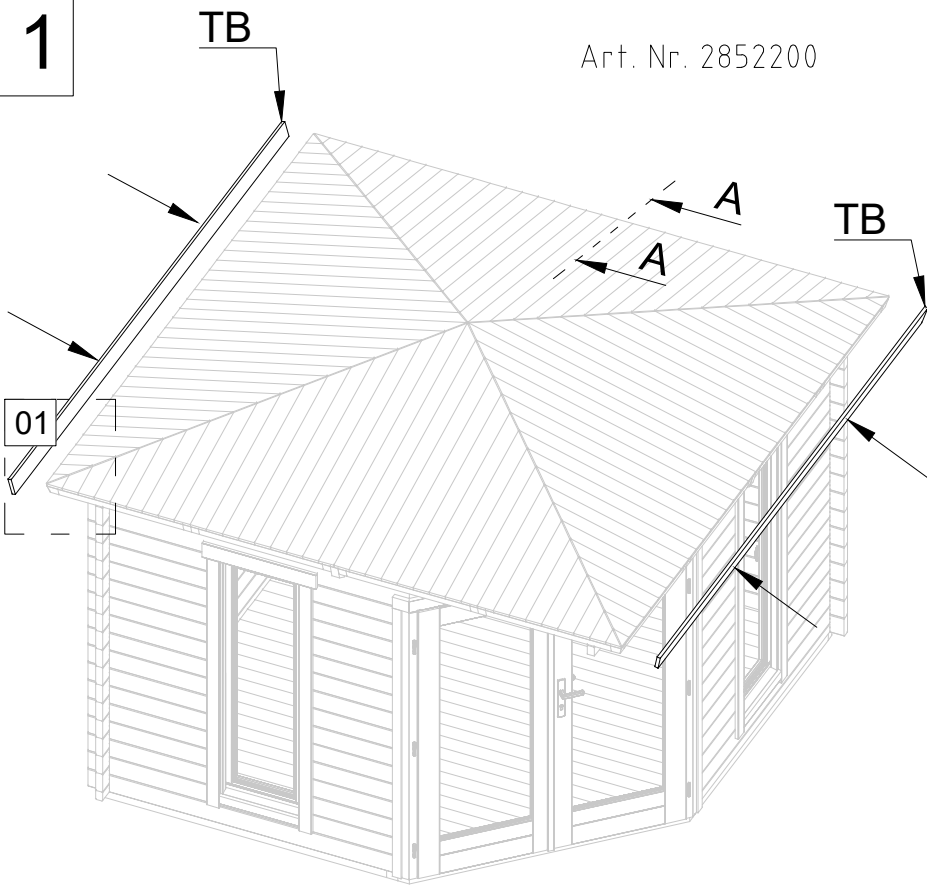

A-A

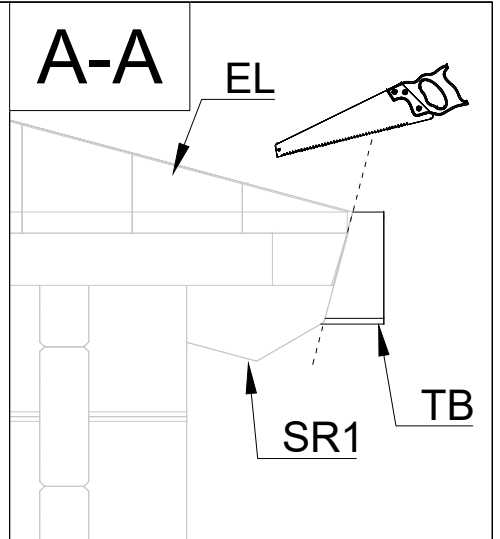

01

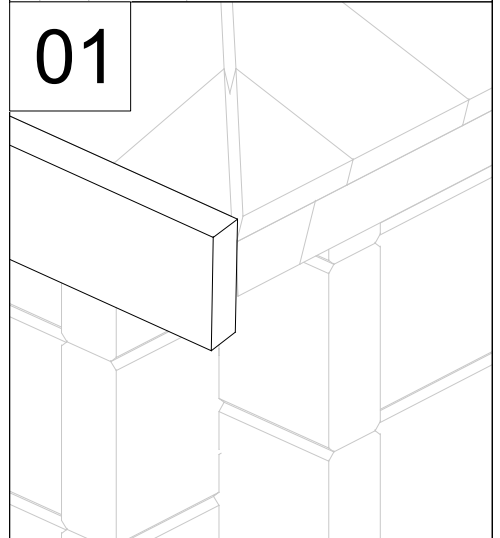

2

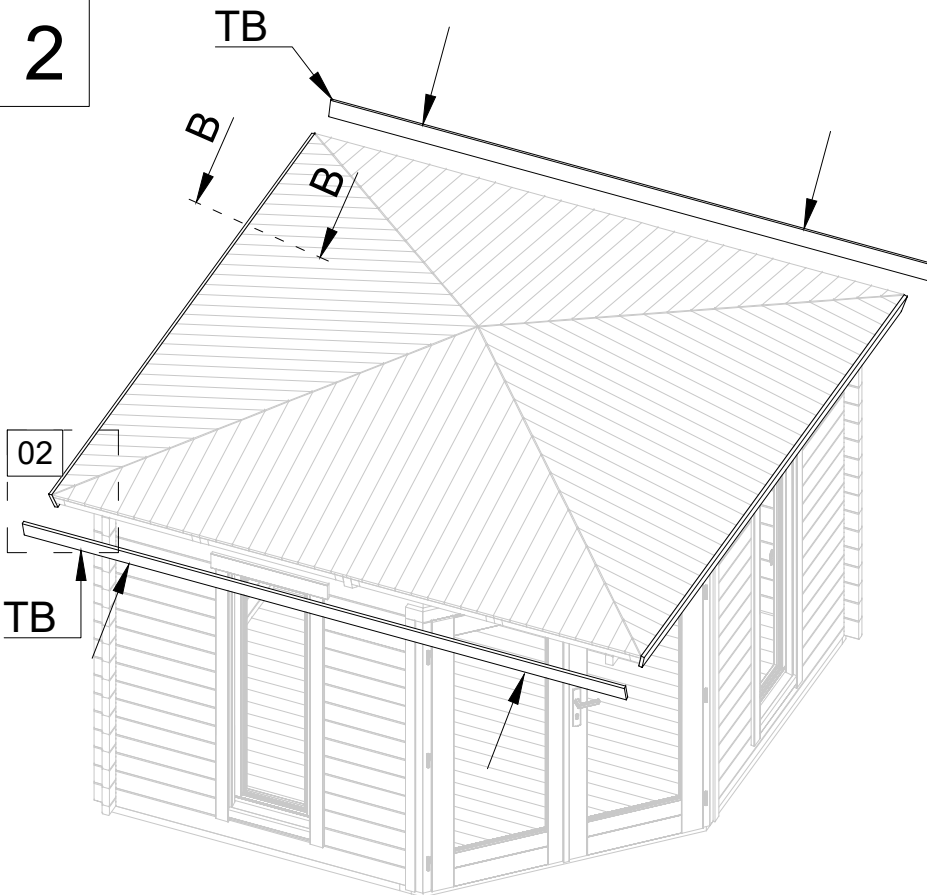



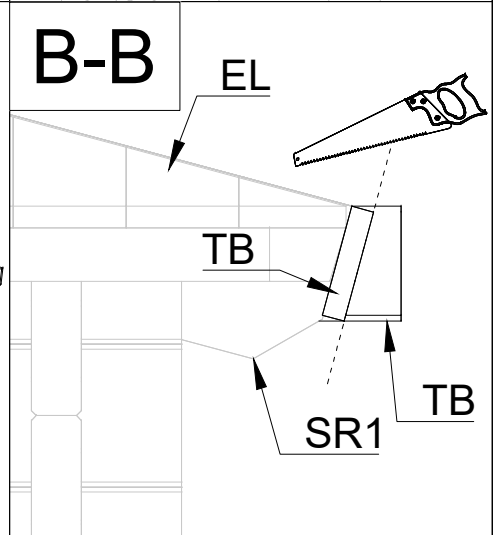



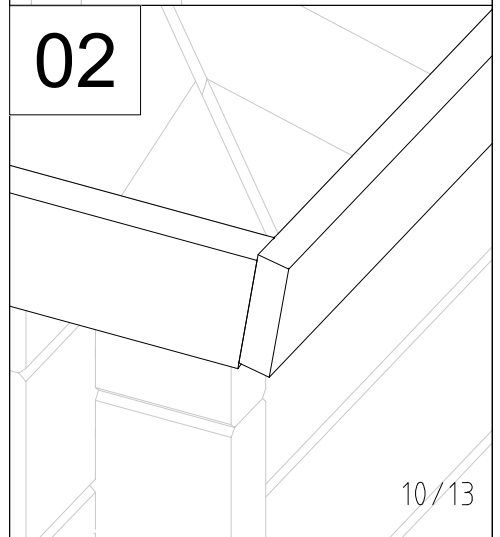

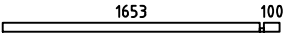
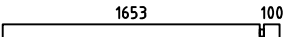

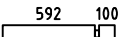
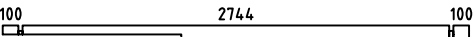
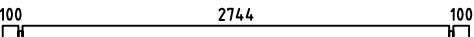
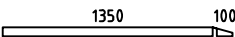
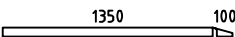
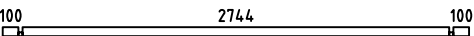
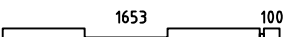
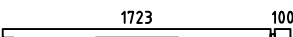
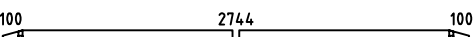
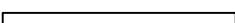
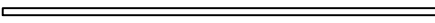
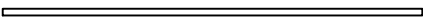

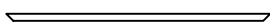

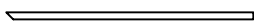
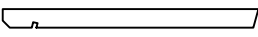

B-B

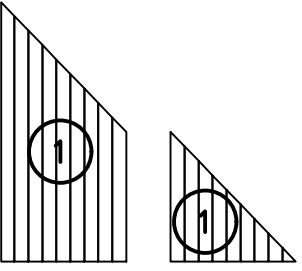
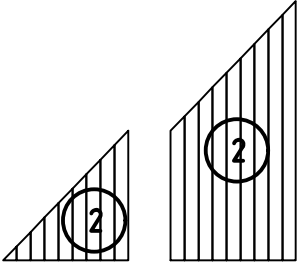
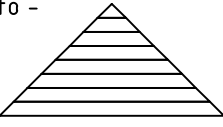
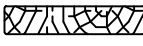
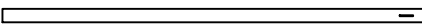

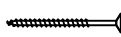

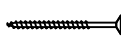
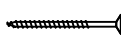

02



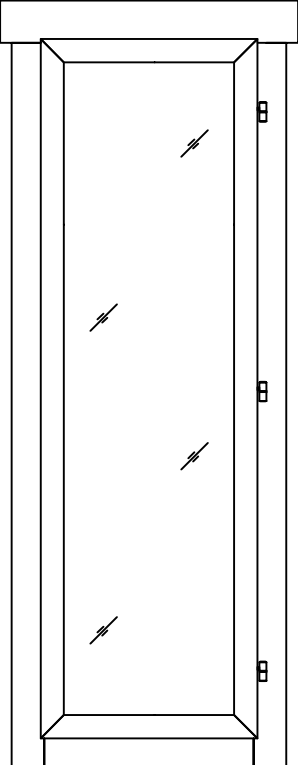
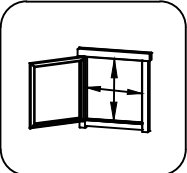



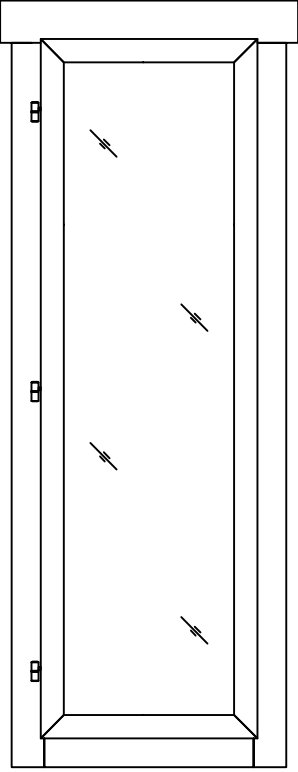
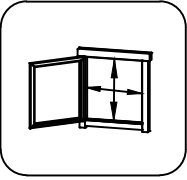

Pos	15.02.2022 Piece list - Stückliste - Liste des pièces - Elementi - Stuklijst - Tükitalabel Art.Nr. 2852200 11/13	Q	P (mm)	L (mm)
001		1	28x57	1781
002		2	28x114	1781
003		27	28x114	526
004		27	28x114	721
005		1	28x114	3000
006		36	28x114	3000
007		2	28x57	1478
008		2	28x57	1478
009		1	28x57	3000
010		1	28x114	1781
011		1	28x114	1851
012		2	28x114	3000
013		1	28x114	1499
IAR2	Foundation - Fundament - Fondation - Fondamenta - Fundering - Immutatud alusraam 	1	45x45	2790
IAR5	Foundation - Fundament - Fondation - Fondamenta - Fundering - Immutatud alusraam 	4	45x45	2700
IAR6	Foundation - Fundament - Fondation - Fondamenta - Fundering - Immutatud alusraam 	1	45x45	2504
IAR7	Foundation - Fundament - Fondation - Fondamenta - Fundering - Immutatud alusraam 	1	45x45	2047
IAR4	Foundation - Fundament - Fondation - Fondamenta - Fundering - Immutatud alusraam 	1	45x45	1698
IAR1	Foundation - Fundament - Fondation - Fondamenta - Fundering - Immutatud alusraam 	1	45x45	1634
IAR3	Foundation - Fundament - Fondation - Fondamenta - Fundering - Immutatud alusraam 	1	45x45	1608
IAR8	Foundation - Fundament - Fondation - Fondamenta - Fundering - Immutatud alusraam 	1	45x45	1589
SR1	Rafter - Dachsparren - Chevron - Trave - Dak spar - Sarikas 	4	44x120	1666
	Floor boards - Fussbodenbretter - Lame de plancher - Pavimento - Vloerhout - Põrandalaud 	31	90x18	2740

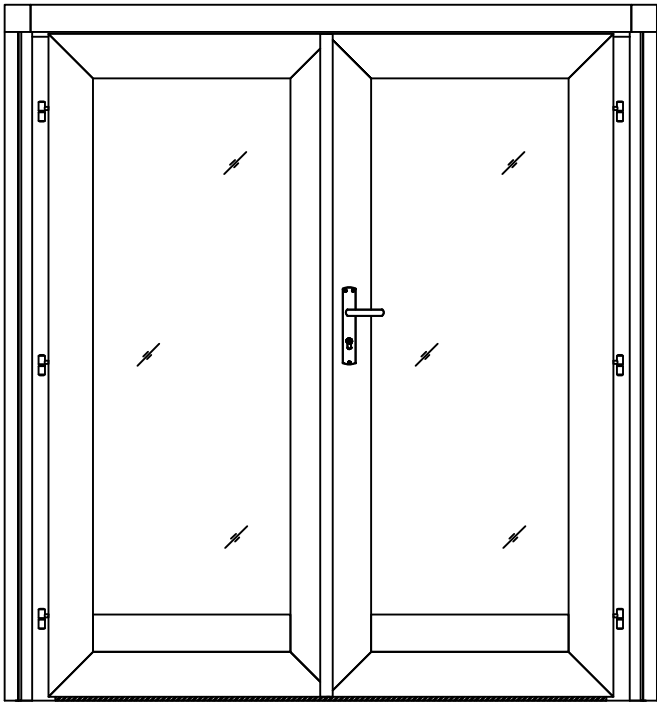
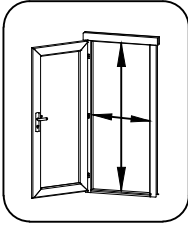
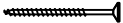
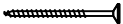
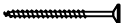
Pos	15.02.2022 Piece list - Stückliste - Liste des pièces - Elementi - Stuklijst - Tükítabel Art.Nr. 2852200 12/13	Q	P (mm)	L (mm)
	Floor fillet - Fussbodenleiste - Corniere de finition du plancher - Finitura per pavimento (battisco pa) - Vloerafwerkljst - Põrandaliist 		18x18	11
EL	Roof element - Dachelement - Panneau de toit pré-monté - Componente del tetto - Dakelement - Katusekilp 	4	62x1612	1668
EL	Roof element - Dachelement - Panneau de toit pré-monté - Componente del tetto - Dakelement - Katusekilp 	4	62x1612	1668
CS	Ceiling shield - Element - Panneau de toiture - Pannello del soffitto - Plafond bedeking - Laekilp 	1	46x722	1443
TB	Fascia board - Traufbrett - Bandeau de toit - Finitura lati tetto - Gevellijst - Räästalaud 	4	18x90	3300
KFS-1	Storm protection - Sturmleiste - Latte anti-tempete - Protezione anti vento - Stormverankering / beveiliging - Tormikinnitusliist 	5	22x45	2050
DT	Roof shield detail - Element - Panneau de toiture - Elementi della copertura superiore del tetto - Katuseelement 	1	44x44	130
HS12	Screw for fascia boards - Schrauben für traufbretter - Vis pour fixation bandeau de toit - Viti x striscia del tetto - Schroef voor gevellijst - Kruvi räästalaule 	28	4x40	
HS13	Screw for triangular fixing - Montagschraube für dreieckige - Vis d'assemblage pour triangle - Vite per fissaggio triangolare - Schroef voor driehoekig afdekljst - Kruvi kolmnurga monteerimiseks seinale 	10	4x60	
HS13	Screw for wall details - Schraube für wand details - Vis pour mur details - Viti per elementi della porta - Schroef voor wand details - Kruvi seinadetailile 	4	4x60	
HS18	Screw for fixing roof elements - Schraube für befestigung dachelementen - Vis de fixation des panneaux de toit - Vite per fissare gli elementi del tetto - Schroef voor bevestiging dakelement - Kruvi kilpide kinnitamiseks seinaga 	48	5x120	
HS18	Screw for roof beams - Schrauben für dachbalken - Vis pour fixation pannes de toit - Viti per perline del tetto - Schroef voor gordingen / dakbalken - Kruvi laetaladele 	12	5x120	
HS16	Screw for 1. wall beam - Schraube für 1. bohlenreihe - Vis de fixations 1ere rangée de madriers avec poutrelles de fondations - Vite fissaggio alle fondamenta - Schroef voor 1 wandbalk - Kruvi poollauale 	4	5x90	
HS16	Screw for foundation - Schrauben zur befestigung fundament - Vis de fixations des poutrelles de fondations - Viti x fondamenta - Schroef voor fundering - Kruvi alusraamile 	20	5x90	
HS16	Screw for wall details - Schraube für wand details - Vis pour mur details - Viti per elementi della porta - Schroef voor wand details - Kruvi seinadetailidele 	2	5x90	
HS21	Screw for fixing roof elements - Schraube für befestigung - dachelementen - Vis de fixation des panneaux de toit - Vite per fissare gli elementi del tetto - Schroef voor bevestiging dakelement - Kruvi kilpide montaažiks 	120	6x80	

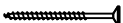
Pos	07.12.2021 Piece list - Stückliste - Liste des pièces - Elementi - Stuklijst - Tükitalabel 525x1560 AK.1.100.SVP.j SGC	1/1	Q	P (mm)	L (mm)
	<p data-bbox="260 152 1284 183">Glass size - Glasgröße - Taille de la vitre - Misura del vetro - Glas afmeting - Klaasi mõõt: 381x1416 mm</p>   <p data-bbox="1364 347 1492 376">425x1460 mm</p>				
FS1	Window handle fittings - Fenstergriff - Poignee de fenetre - Maniglia c/ferramenta - Raamhendel -/grendel -/klink - Aknalink		2		
FSP	Bolt for window handle fittings - Bolzen für fenstergriff beschlag - Vis pour fixation poignee de fenetre - Bullone x apertura manuale finestra - Schroef voor raamhendel - Akna käepideme polt		4		

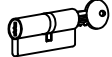
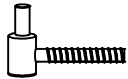
Pos	07.12.2021 Piece list - Stückliste - Liste des pièces - Elementi - Stuklijst - Tükitalabel 525x1560 AK.1.100.SVV.j SGC	1/1	Q	P (mm)	L (mm)
	<p data-bbox="258 152 1284 183">Glass size - Glasgröße - Taille de la vitre - Misura del vetro - Glas afmeting - Klaasi mõõt: 381x1416 mm</p>   <p data-bbox="1364 347 1497 376">425x1460 mm</p>				
FS1	Window handle fittings - Fenstergriff - Poignee de fenetre - Maniglia c/ferramenta - Raamhendel -/grendel -/klink - Aknalink		2		
FSP	Bolt for window handle fittings - Bolzen für fenstergriff beschlag - Vis pour fixation poignee de fenetre - Bullone x apertura manuale finestra - Schroef voor raamhendel - Akna käepideme polt		4		

Pos	07.12.2021	Piece list - Stückliste - Liste des pièces - Elementi - Stuklijst - Tükitalabel 14.94x1736 TUK.1.100.SVP.MM5c SGC	1/1	Q	P (mm)	L (mm)
		Glass size - Glasgröße - Taille de la vitre - Misura del vetro - Glas afmeting - Klaasi mõõt: 524x1397 mm				
		  <p>1418x1679 mm</p>				
HS3	Screw for door fillet - Schraube zur Befestigung Türleiste - Vis pour fixation baguette d'arrêt de porte - Viti per massellino della porta - Schroef voor deurlijst - Krugi ukse kokkuvaltšiliistule		5	3x30		
HS22	Screw for fixing door to the wall - Schraube zur Befestigung Tür - zarge mit wand - Vis de fixation partie basse dormant de porte au 1er rang de madrier - Viti per fissare la porta alla parete - Schroef voor bevestiging deur naar wand - Krugi ukseleugi kinnitamiseks seinale		2	3.5x50		
HS45	Screw for covering moulding - Schrauben für deckungsprofil - Vis de fixation profils horizontaux haut inférieur et extérieur d'encadrement de porte - Vite per cornice di copertura - Schroef voor afdekprofiel - Krugi piirdelauale		26	4x40		
HS41	Screw for door jamb - Schraube für Türrahmen - Vis de fixation partie haute avec montants du cadre de porte - Viti x fissaggio montanti porte - Schroef voor deurkozijn - Krugi ukse lengile		4	5x90		
HS59	Screw for doorstep - Schrauben für swelle - Vis pour fixation barre de seuil - Vite per soglia della porta - Schroef voor deurdorpel - Krugi lävepakule		3	4.5x65		
TL4	Door handle fittings - Türgriff - Poignée de porte - Maniglie - Deurhendel / klink - Ukse käepide		1			
TL5	Set of door lock covers - Schlossblenden - Set de garnitures de porte - Copertura serrature - Slot sluitplaat set - Ukse lukuplaat		1			
	Cylinder lock - Zylinderschloss - Barillet de porte - Serratura - Cylinder slot - Ukse lukusüdamik		1	30x35		
	Male bolt hinge for door - Türband - Partie male de paumelle de porte - Cerniera anube x porta - Scharnier bout - Ukse polthing isane		6			
	Striker for barrel bolt - Hülse für Grendelriegel - Gache au sol du targette - Boccola per fermo della porta - Huls voor vergrendelingsschuif - Vasturaud ukse servariivile		2			

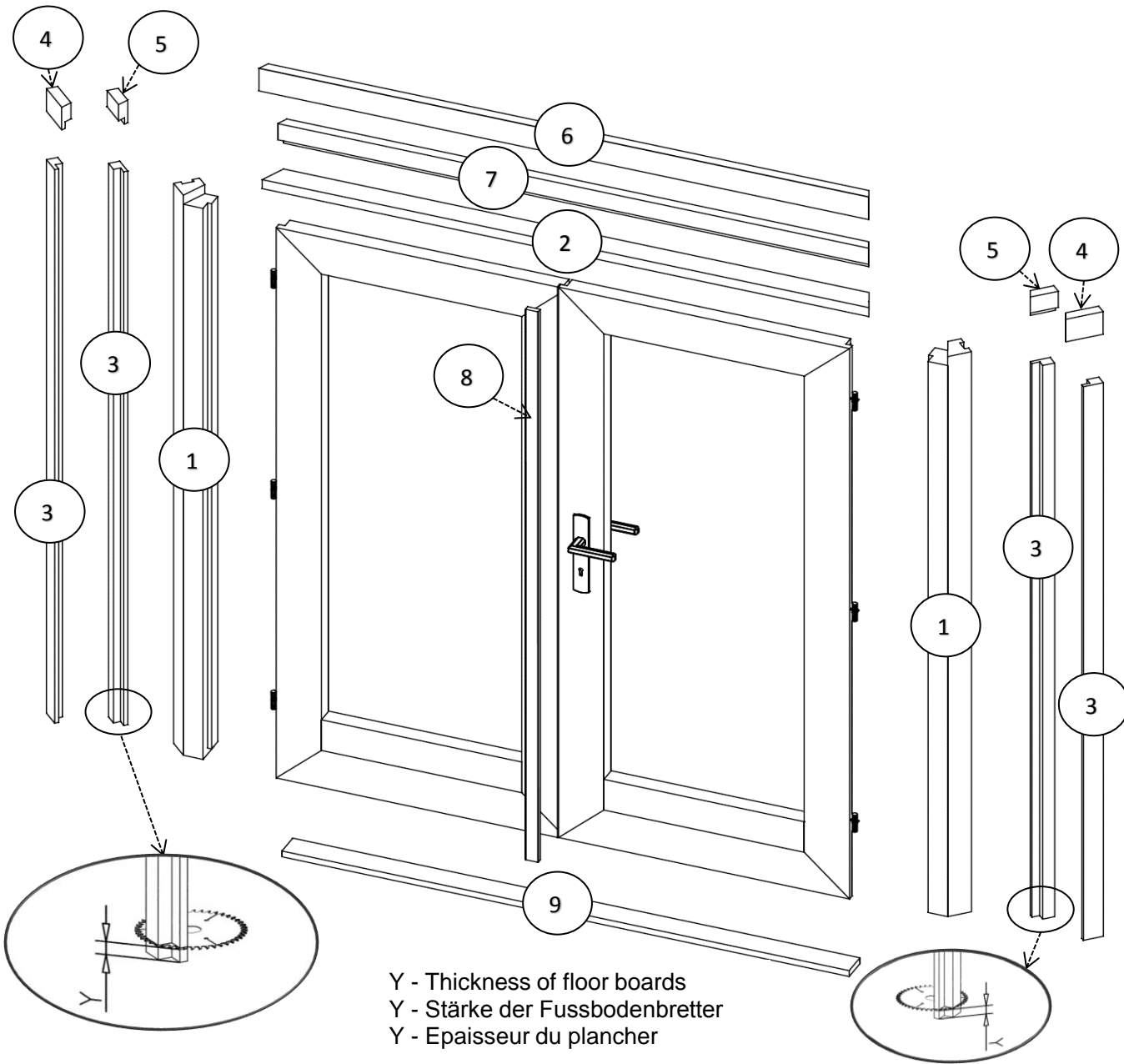

Allgemeine Montageanleitung - General assembly instructions - Instructions générales de montage

Pos	Piece list - Stückliste - Liste des pièces	Q.	P (mm)	L (mm)
1		2	65x60	1736
2		1	65x38	1538
3		4	28x50	1721
4		2	28x70	94
5		2	28x70	71
6		1	28x70	1546
7		1	28x70	1499
8		1	13x32	1706
9		1	18x65	1438

