

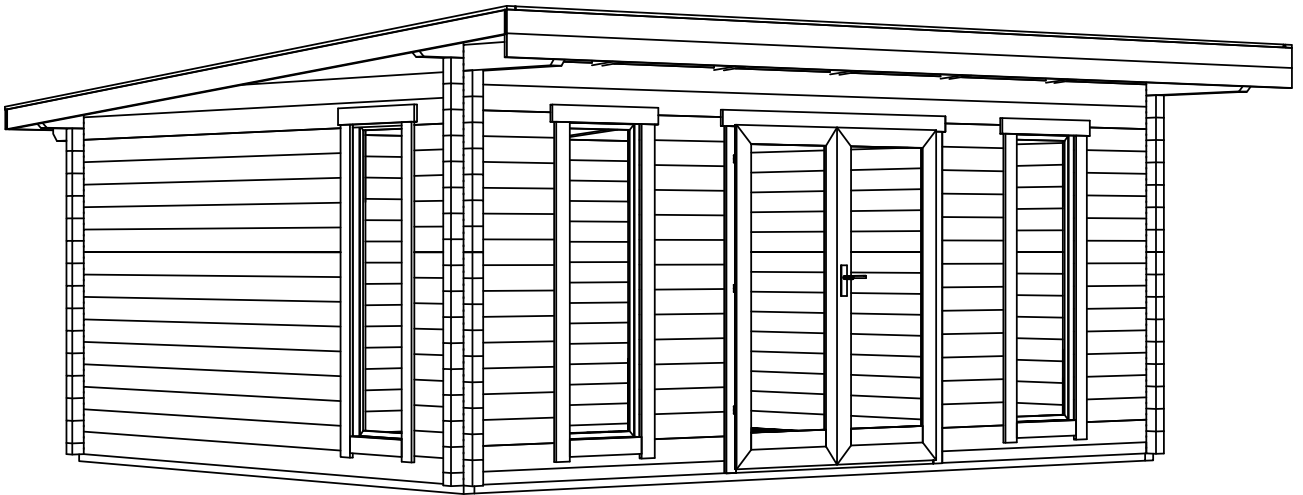

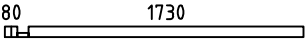

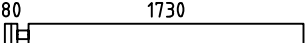

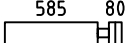

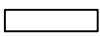
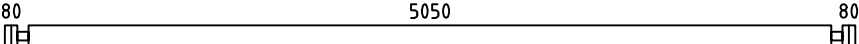
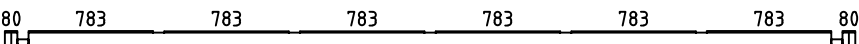
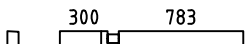
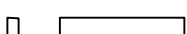
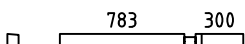
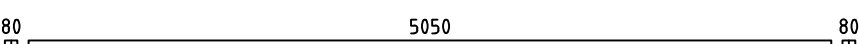
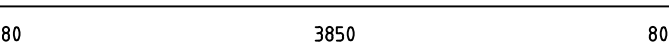
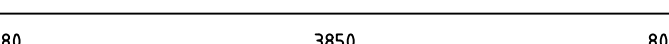
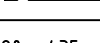
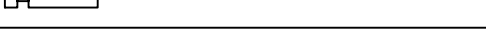
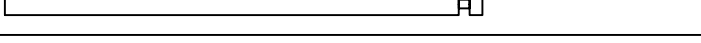
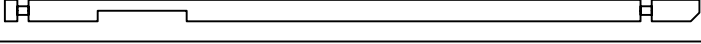
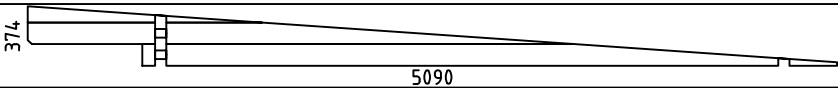
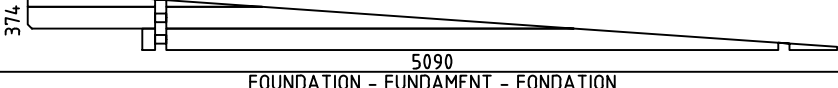
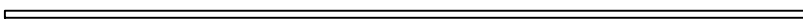

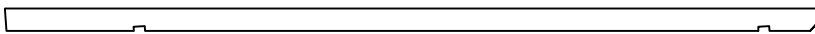
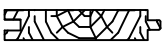
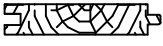





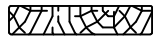
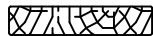



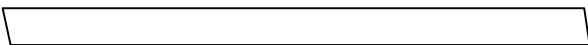

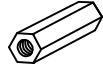

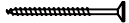
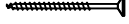

*BARBADOS 5*  
*Art.No. 7010702*

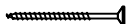
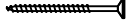

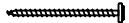
| Pos  | BARBADOS 5, Art.Nr. 7010702<br>Piece list - Stückliste - Liste des pieces  | Q.  | P<br>(mm) | L<br>(mm) |
|------|--|-----|-----------|-----------|
| 001  |   | 2   | 70x68     | 1880      |
| 002  |   | 2   | 70x136    | 1880      |
| 003  |   | 26  | 70x136    | 735       |
| 004  |   | 26  | 70x136    | 585       |
| 005  |    | 14  | 70x136    | 5350      |
| 006  |    | 2   | 70x136    | 5350      |
| 007  |   | 2   | 70x115    | 1153      |
| 008  |   | 8   | 70x115    | 783       |
| 009  |   | 2   | 70x115    | 1153      |
| 010  |    | 1   | 70x68     | 5350      |
| 011  |   | 15  | 70x136    | 4150      |
| 012  |   | 1   | 70x136    | 4150      |
| 013  |   | 12  | 70x136    | 585       |
| 014  |   | 12  | 70x136    | 3005      |
| 015  |   | 1   | 70x136    | 4370      |
| 019  |   | 1   | 70x136    | 4370      |
| WA-1 |    | 1   |           |           |
| WB-1 |    | 1   |           |           |
| IAR2 | FOUNDATION - FUNDAMENT - FONDATION<br>   | 9   | 70x45     | 5040      |
| IAR1 | FOUNDATION - FUNDAMENT - FONDATION<br>  | 2   | 70x45     | 3980      |
| SR1  | RAFTER - DACHSPARREN - CHEVRON<br>   | 5   | 70x140    | 5112      |
| FB   | FLOOR BOARDS - FUSSBODENBRETTER - LAME DE PLANCHER                                | 57  | 90x18     | 3846      |
| RB   | ROOF BOARDS - DACHBRETTER - VOLIGES   | 114 | 90x18     | 2895      |
|      | FLOOR FILLET-FUSSBODENLEISTE - CORNIERE DE FINITION DU PLANCHER                   |     | 18x18     | 17.8 m    |
| DPL1 | ROOFING FELT FILLET - DACHPAPPENLEISTE - BAGUETTE DE FIXATION DU FEUTRE BITUMEUX  | 2   | 18x58     | 2915      |

| Pos  | BARBADOS 5, Art.Nr. 7010702<br>Piece list - Stückliste - Liste des pieces  |   | Q. | P<br>(mm) | L<br>(mm) |
|------|--|---|----|-----------|-----------|
| DPL2 | ROOFING FELT FILLET - DACHPAPPENLEISTE - BAGUETTE DE FIXATION DU FEUTRE BITUMEUX                                   |    | 2  | 18x58     | 5080      |
| M12  | TREADED ROD M12 - GEWINDESTANGE M12 - TIGE FILETÉE M12   |    | 2  |           | 90        |
| M12  | TREADED ROD M12 - GEWINDESTANGE M12 - TIGE FILETÉE M12   |    | 2  |           | 390       |
| M12  | TREADED ROD M12 - GEWINDESTANGE M12<br>TIGE FILETÉE M12  |     | 4  |           | 2000      |
| TB1  | EAVES BOARD - TRAUFBRETT - BANDEAU DE TOIT   |    | 3  | 18x120    | 2062      |
| TB2  | EAVES BOARD - TRAUFBRETT - BANDEAU DE TOIT   |    | 3  | 18x120    | 3768      |
| DRV1 | ROOF EDGE REINFORCEMENT - DACHRANDVERSTÄRKUNG - CORNIERE DE RENFORT DE BORD DE TOIT                                |    | 2  | 28x34     | 297       |
| DRV2 | ROOF EDGE REINFORCEMENT - DACHRANDVERSTÄRKUNG - CORNIERE DE RENFORT DE BORD DE TOIT                                |    | 2  | 28x34     | 798       |
| DRV3 | ROOF EDGE REINFORCEMENT - DACHRANDVERSTÄRKUNG - CORNIERE DE RENFORT DE BORD DE TOIT                                |    | 2  | 28x34     | 3850      |
| GL   | GABLE MOULDING - GIEBELLEISTE<br>PLANCHE DE RIVE   |     | 2  | 18x120    | 5111      |
| SH70 | HAMMER BLOCK - SCHLAGHOLZ - CALLE DE FRAPPE  |   | 1  |           |           |
| KL4  | LENGTHENING BOLT FOR TREADED ROD - VERLÄNGERUNGSMUTTER FÜR GEWINDESTANGE - MANCHON DE RACCORDEMENT DE TIGE FILETÉE |  | 4  |           |           |
| KL1  | DRIVE NUT TREADED ROD - EINSHLAGMUTTER FÜR GEWINDESTANGE - ÉCROU A FRAPPER POUR TIGE FILITÉE                       |  | 4  |           |           |
| KL2  | NUT FOR TREADED ROD - MUTTER FÜR GEWINDESTANGE - ÉCROU POUR TIGE FILETÉE   |  | 4  |           |           |
| KL3  | PLAIN WASHER TREADED ROD - UNTERLEGSCHIEBE FÜR GEWINDESTANGE - RONDELLE PLATE POUR TIGE FILETÉE                    |  | 4  |           |           |
| HS32 | SCREW FOR EAVES BOARDS - SCHRAUBEN FÜR TRAUFBRETT<br>VIS DE FIXATION POUR BANDEAU DE TOIT                          |  | 37 | 3.5x50    |           |
| HS16 | SCREW FOR GABLE MOULDING - SCHRAUBEN FÜR GIEBELLEISTE<br>VIS DE FIXATION POUR PLANCHE DE RIVE                      |  | 38 | 3.5x50    |           |
| HS26 | SCREW FOR ROOF EDGE REINFORCEMENT - SCHRAUBEN FÜR DACHRANDVERSTÄRKUNG - VIS POUR RENFORT DE BORD DE TOIT           |  | 28 | 4x40      |           |
| HS40 | SCREW FOR 1. WALL BEAM - SCHRAUBE FÜR 1. BOHLENREIHE<br>VIS DE FIXATION DES FONDATIONS                             |  | 8  | 5x120     |           |
| HS39 | SCREW FOR FUNDAMENT - SCHRAUBEN ZUR BEFESTIGUNG FUNDAMENT<br>- VIS POUR FONDATION                                  |  | 13 | 5x120     |           |
| HS42 | SCREW FOR GABLE - SCHRAUBEN FÜR GIEBEL - VIS POUR FIXATION DES PIGNONS   |  | 6  | 5x120     |           |
| HS48 | SCREW FOR Pos. 007-009, SCHRAUBEN FÜR Pos. 007-009<br>VIS POUR Pos. 007-009  |  | 24 | 6x180     |           |
| HS44 | SCREW FOR RAFTER - SCHRAUBEN ZUR BEFESTIGUNG DACHSPARREN<br>- VIS POUR CHEVRON                                     |  | 10 | 6x180     |           |
| MS   | SCREW FOR DOORSTEP - SCHRAUBEN FÜR TÜRSCHWELLE - VIS DE FIXATION DU SEUIL DE PORTE                                 |  | 3  | 4.5x65    |           |
| NFD  | ZN NAIL FOR ROOFING FELT FILLET - ZN NÄGEL FÜR DACHPAPPENLEISTE - POINTE POUR BAGUETTE FIXATION FEUTRE BITUMEUX    |  | 50 | 2x40      |           |

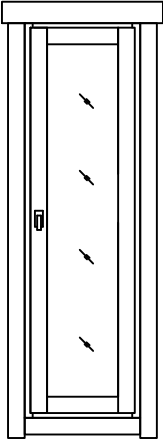
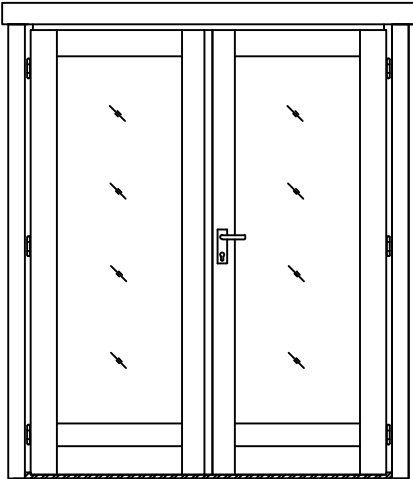
| Pos          | BARBADOS 5, Art.Nr. 7010702<br>Piece list - Stückliste - Liste des pieces   | Q.  | P<br>(mm) | L<br>(mm) |
|--------------|---|-----|-----------|-----------|
| NFF          | ZN NAIL FOR FILLETS - ZN NÄGEL FÜR LEISTEN - POINTE POUR CORNIERE        | 38  | 1.4x40    |           |
| NF2          | ZN NAIL FOR ROOF - ZN NÄGEL FÜR DACHBRETTER - POINTE POUR TOIT           | 472 | 2x50      |           |
| NH1          | ZN NAIL FOR FLOOR - ZN NÄGEL FÜR FUSSBODENBRETTER - CLOUS POUR PLANCHER  | 522 | 2x50      |           |
| ORZ          | MONTAGE SET FOR DOORS AND WINDOWS - MONTAGE-SET FÜR TÜREN UND FENSTER - JEU DE MONTAGE PORTES ET FENETRES   | 1   |           |           |
| 3+<br>A.OP.b | WINDOW-FENSTER-FENETRE 552x1729<br>                                       | 3   |           |           |
| 2+<br>TU.10P | DOOR-TÜR-PORTE 1580x1933<br>   | 1   |           |           |



BARBADOS 5, Art.Nr. 7010702  
RAFTER - DACHSPARREN - CHEVRON

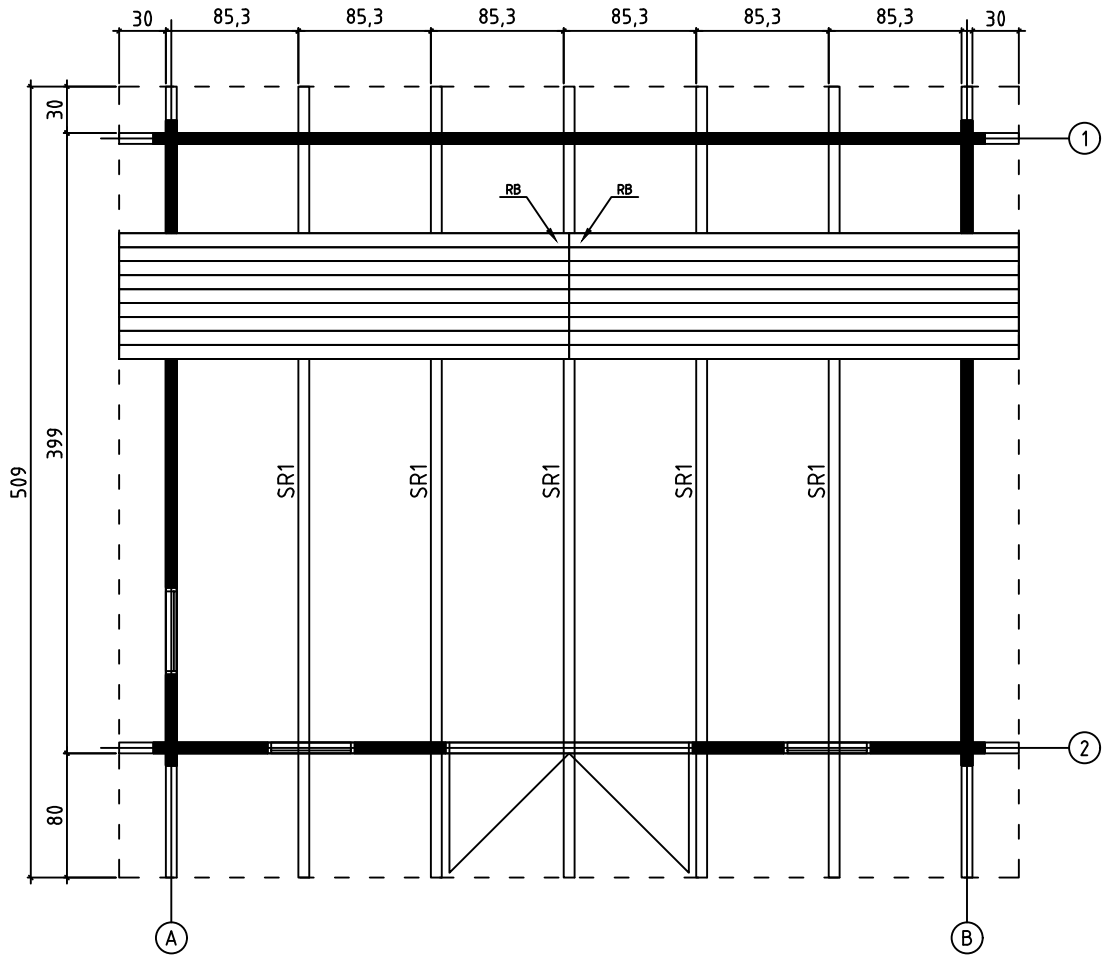

FLOOR BOARDS - FUSSBODENBRETTER - PLAN POSE PLANCHER

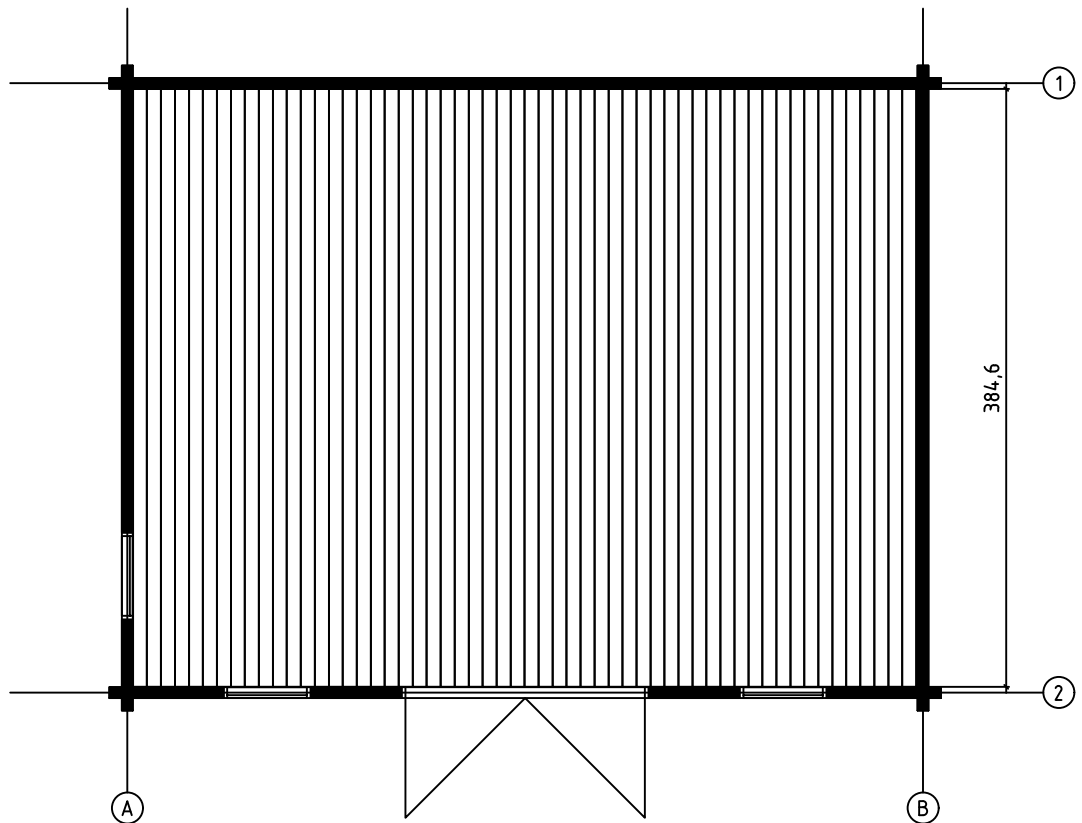

BARBADOS 5, Art.Nr. 7010702

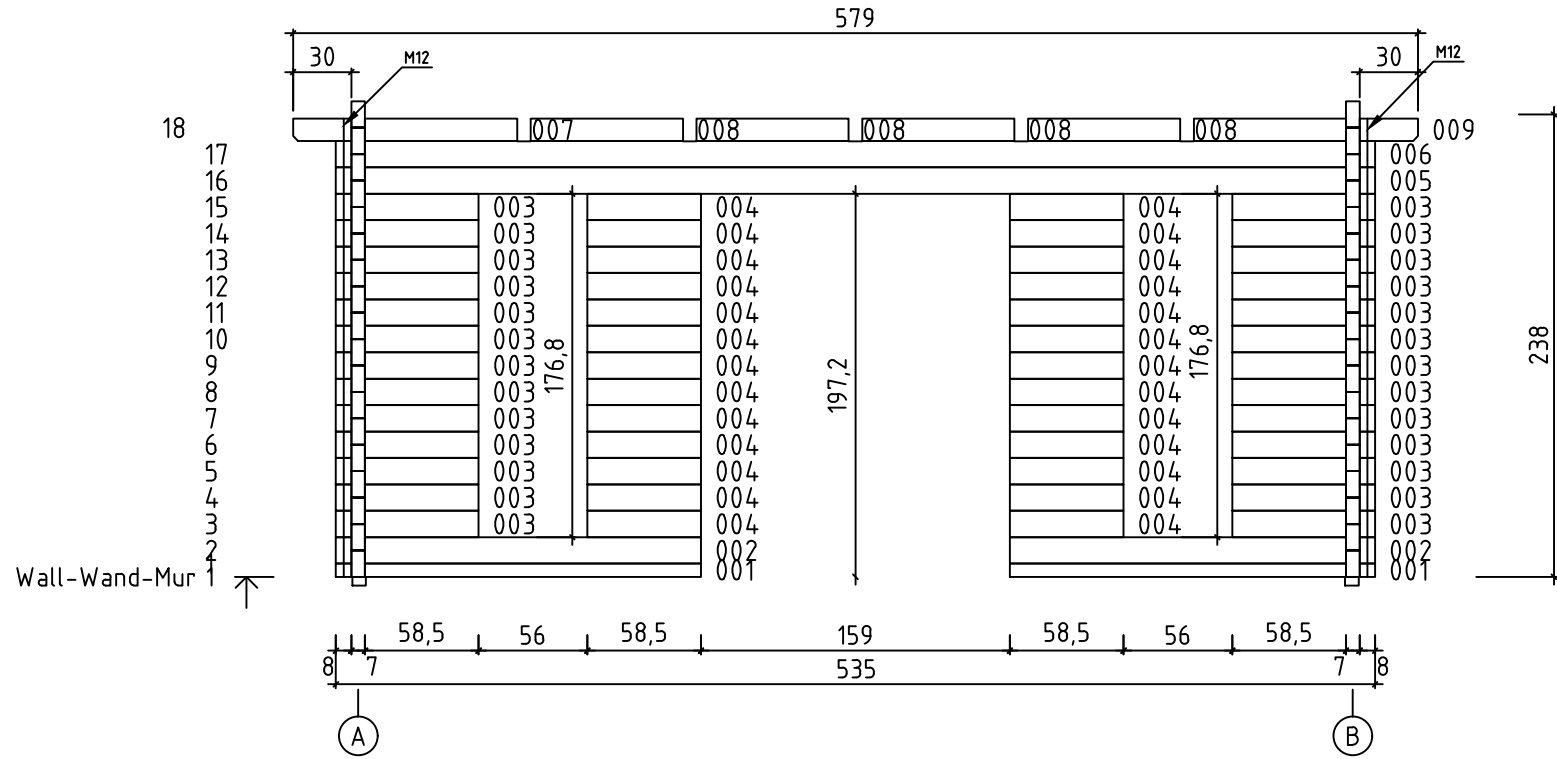

BARBADOS 5, Art.Nr. 7010702

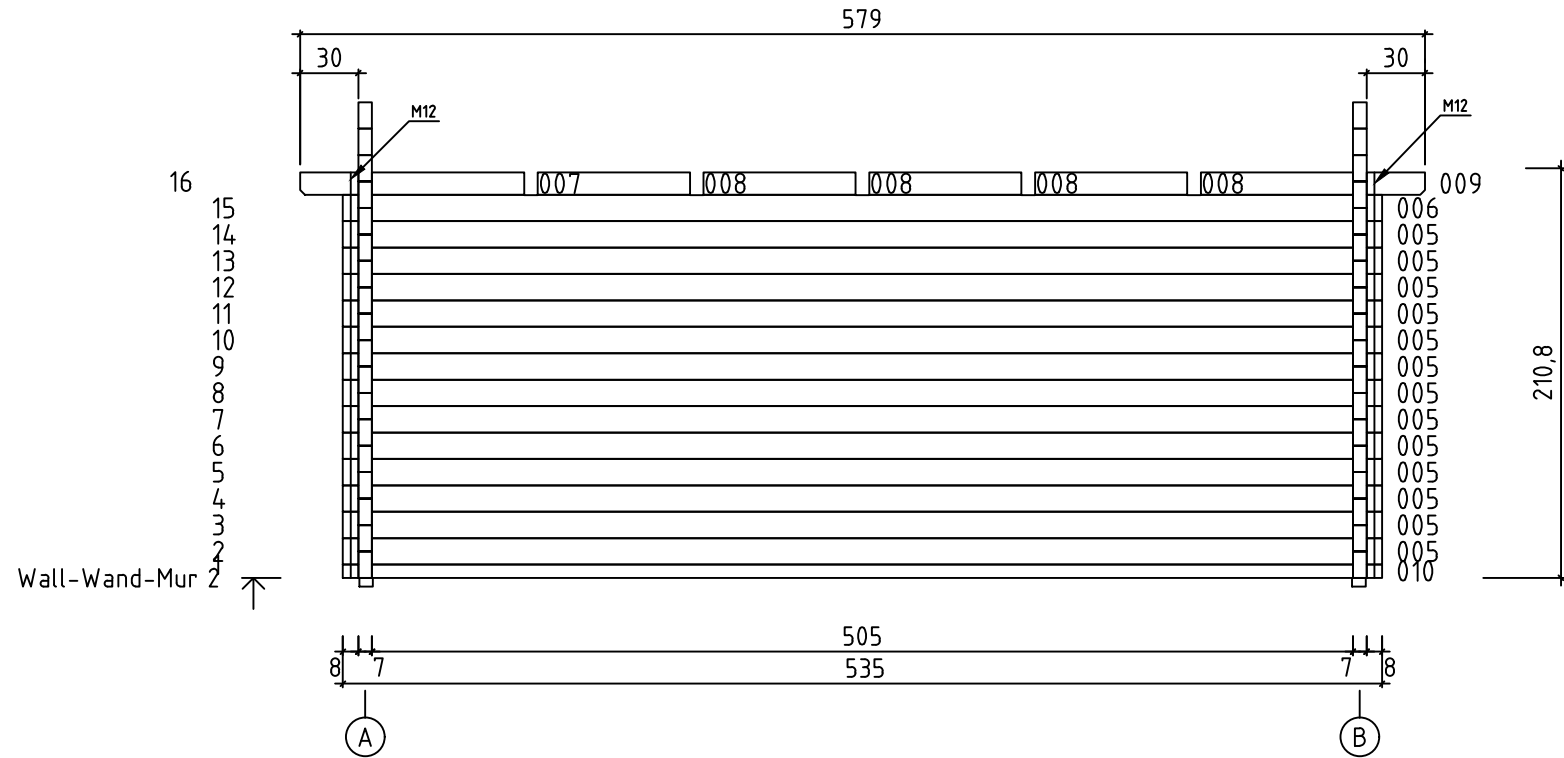



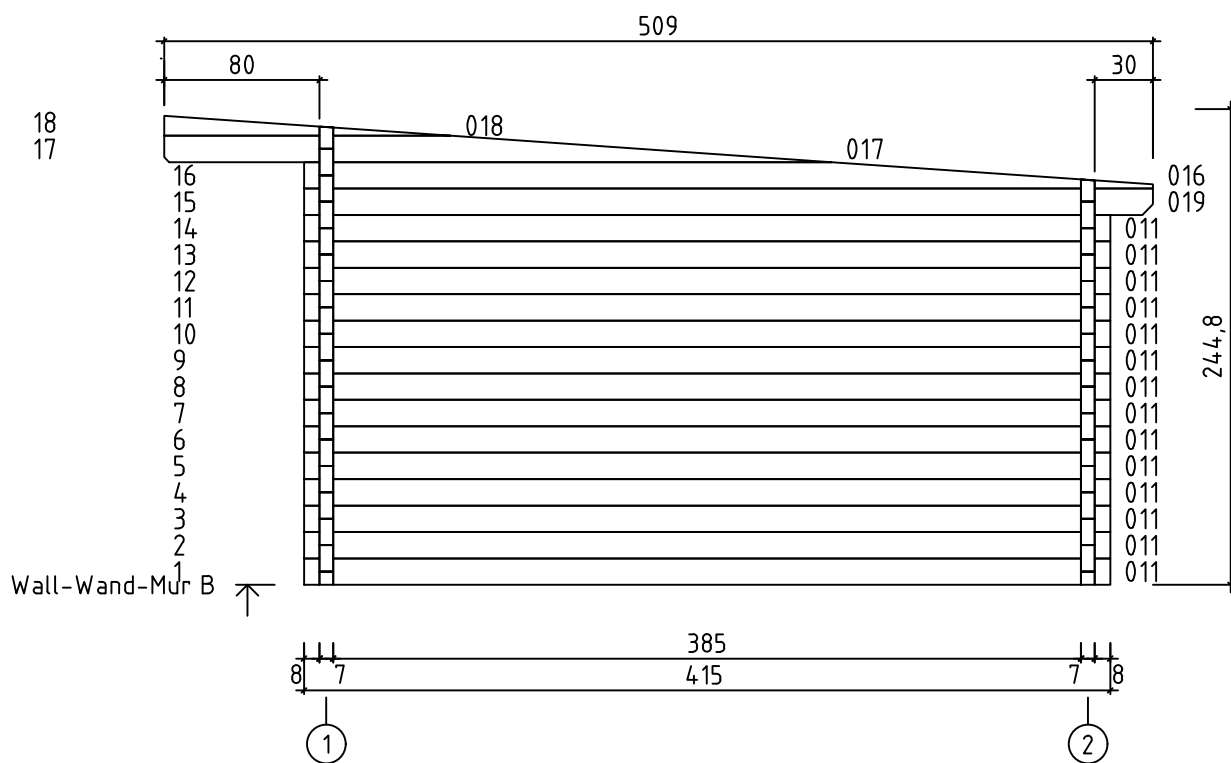
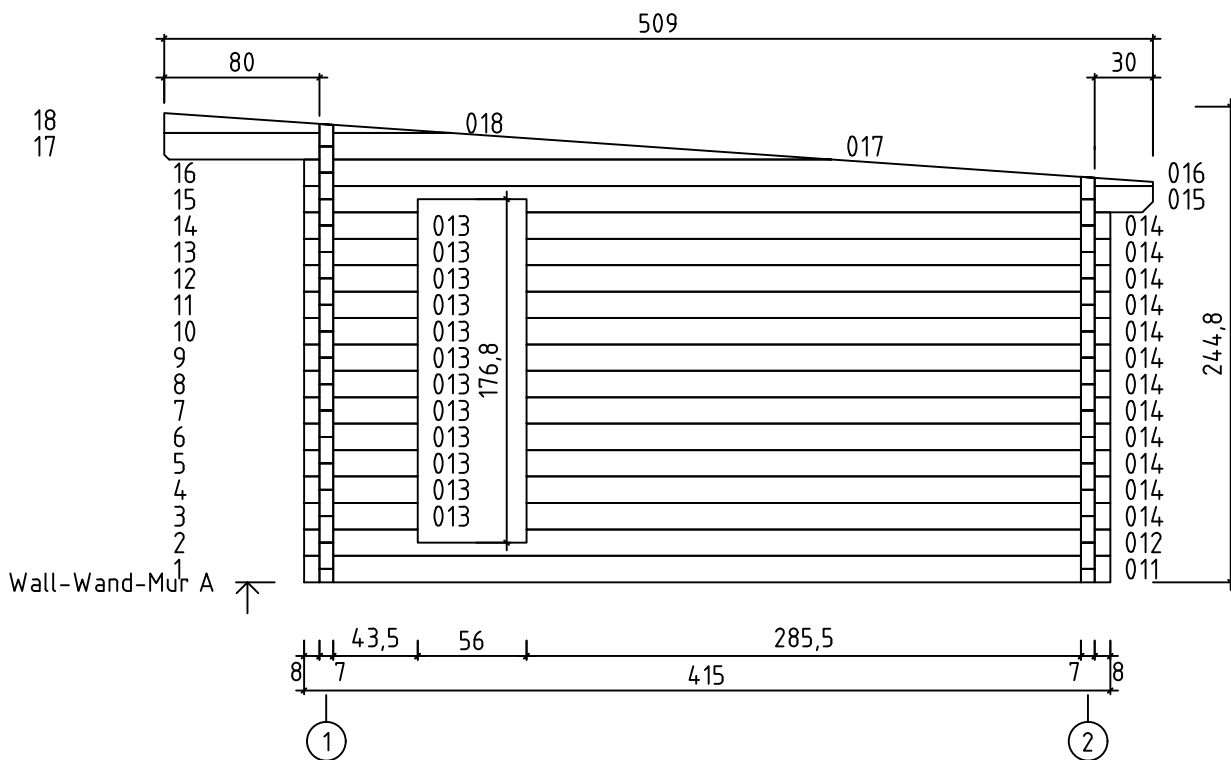

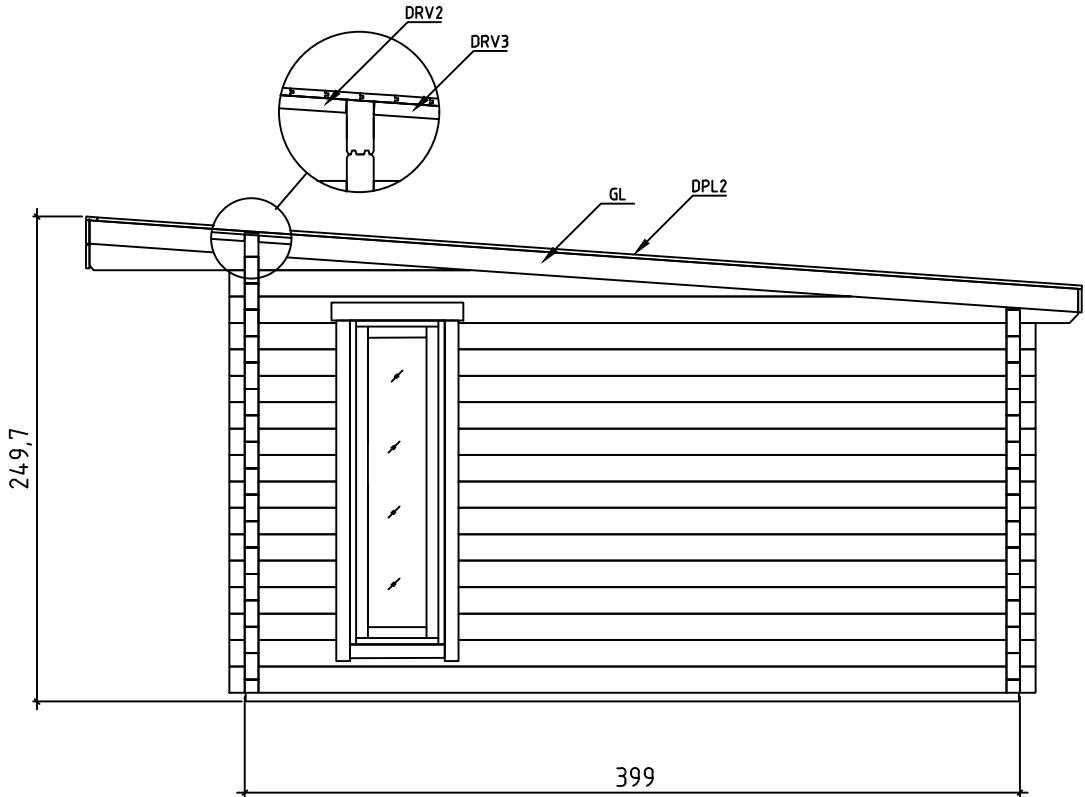
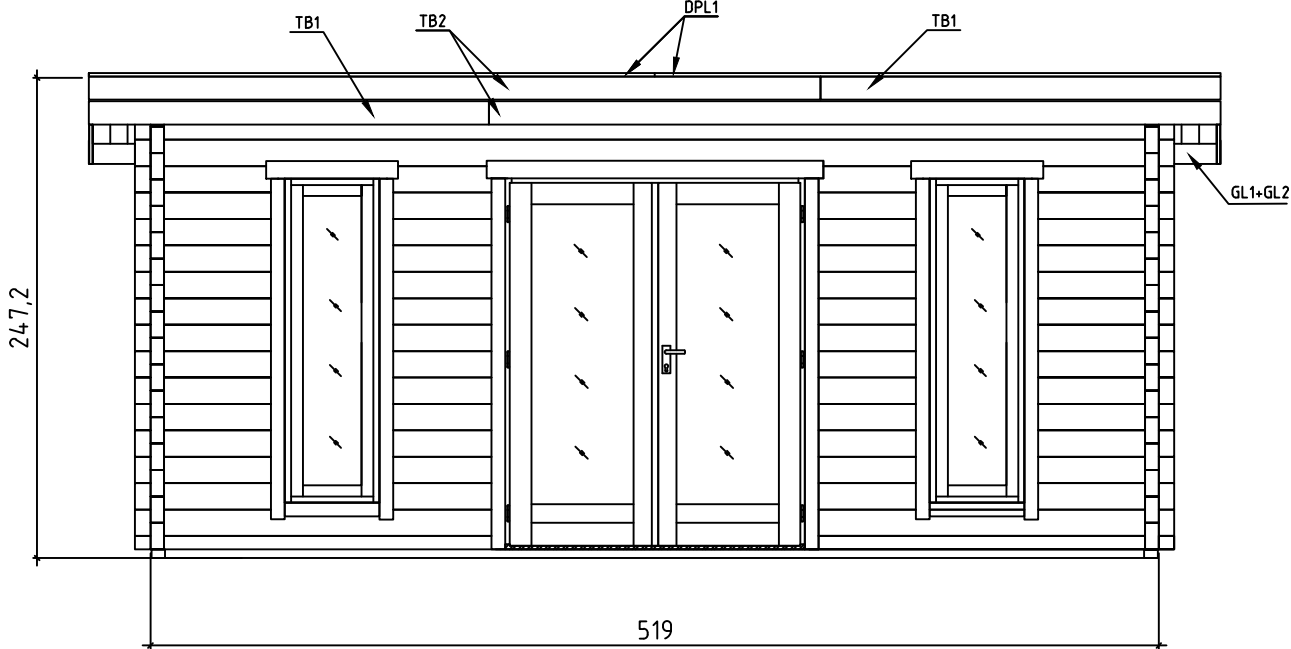

OP1

Only double door  
Doppeltür  
Seulement double porte

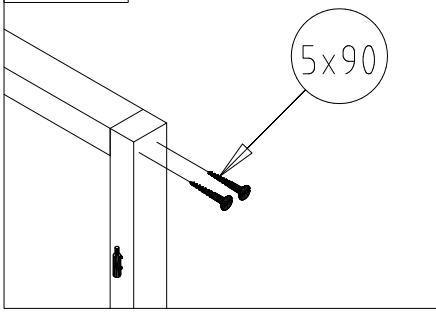

5x90

OP3

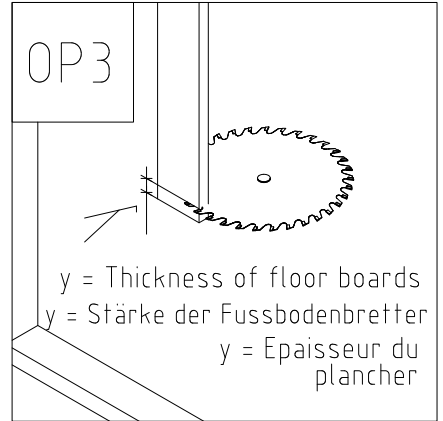

y = Thickness of floor boards  
y = Stärke der Fussbodenbretter  
y = Epaisseur du plancher

OP1  
Only double door  
Doppeltür  
Seulement double porte

5x90

Optional  
Optional  
Optionnel

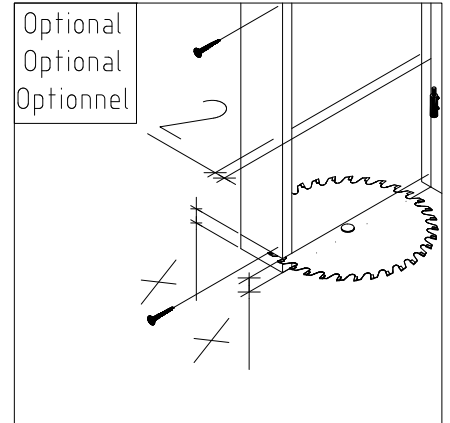

OP4

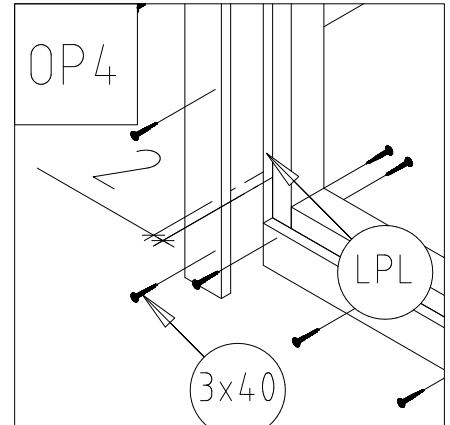

LPL

3x40

OP4

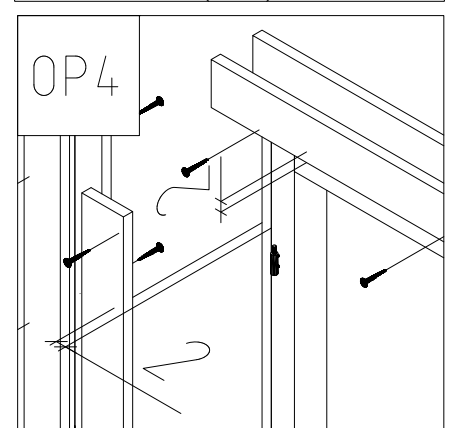

OP4

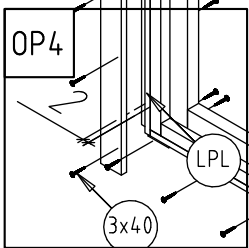

LPL

3x40

OP4

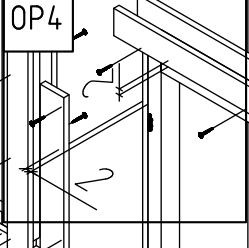

Optional  
Optional  
Optionnel

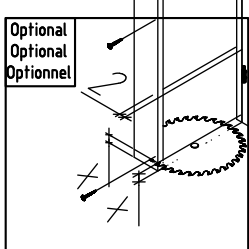

OP3

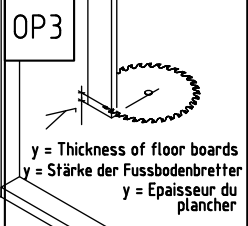

y = Thickness of floor boards  
y = Stärke der Fussbodenbretter  
y = Epaisseur du plancher

x = Thickness of terrace/floor boards in front of the door  
x = Stärke der Terrassen - und Fussbodenbretter vor der Tür  
x = Epaisseur du terrasse/plancher en face de la porte

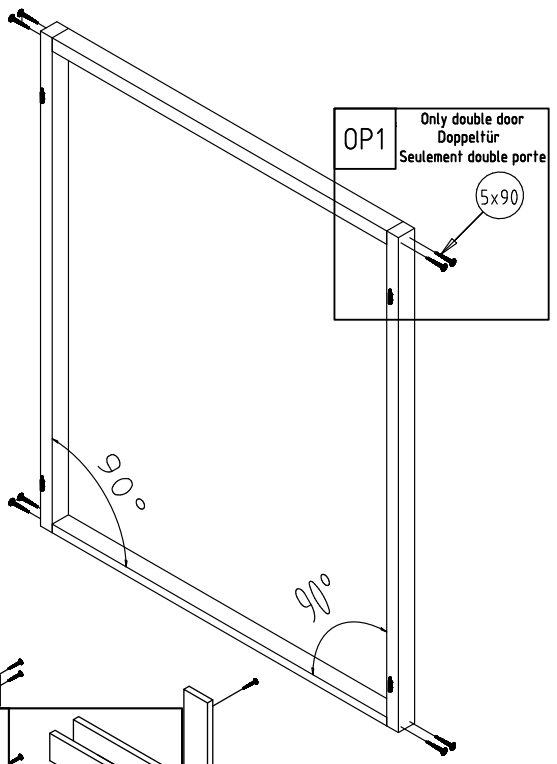

OP1

Only double door  
Doppeltür  
Seulement double porte

5x90

90°

90°

18x90

18x90

