

Bike Extension 2000
Art. Nr. 2829200
1/8

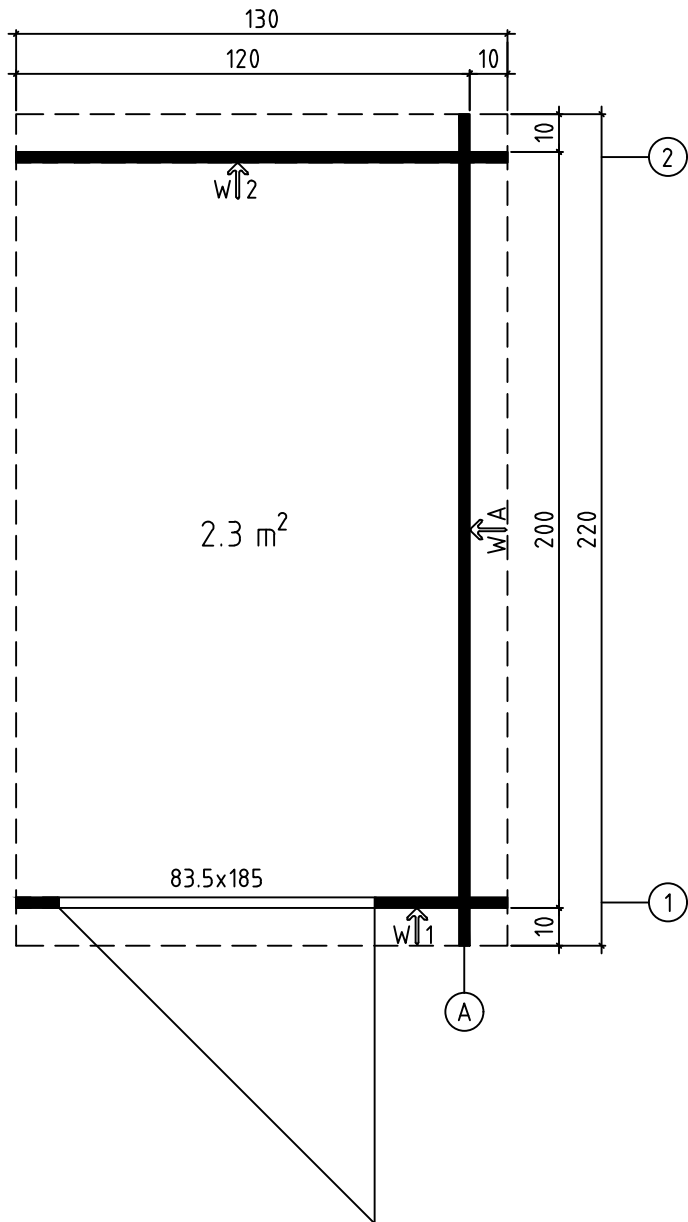

GROUNDPLAN - GRUNDPLAN -
PLAN DE MASSE



FOUNDATION - FUNDAMENT - FONDATION

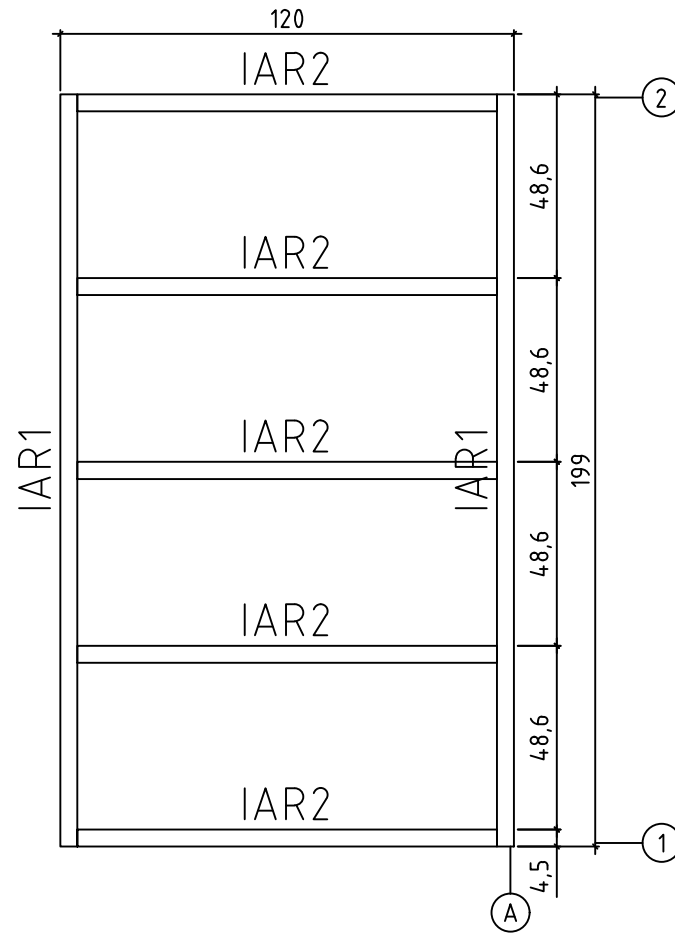



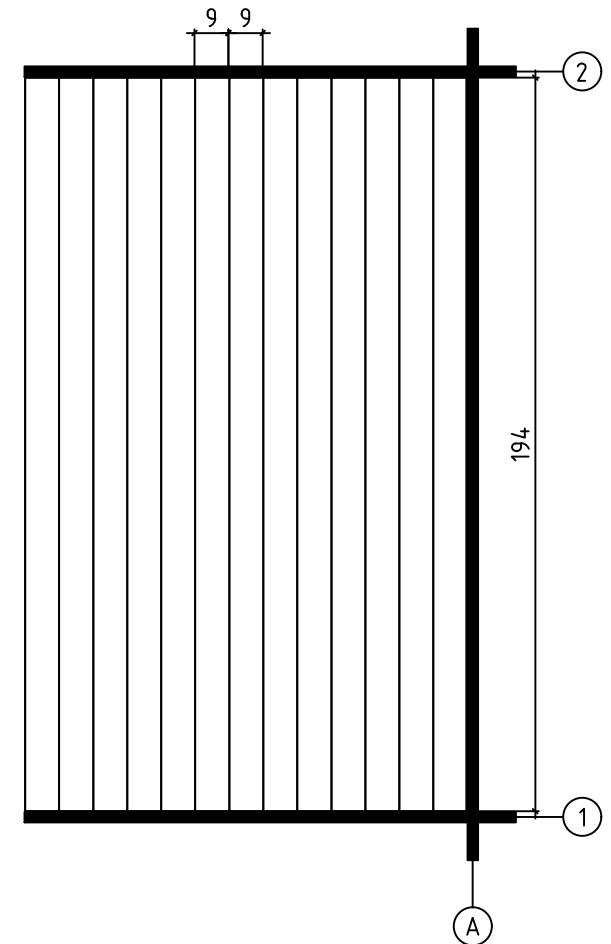

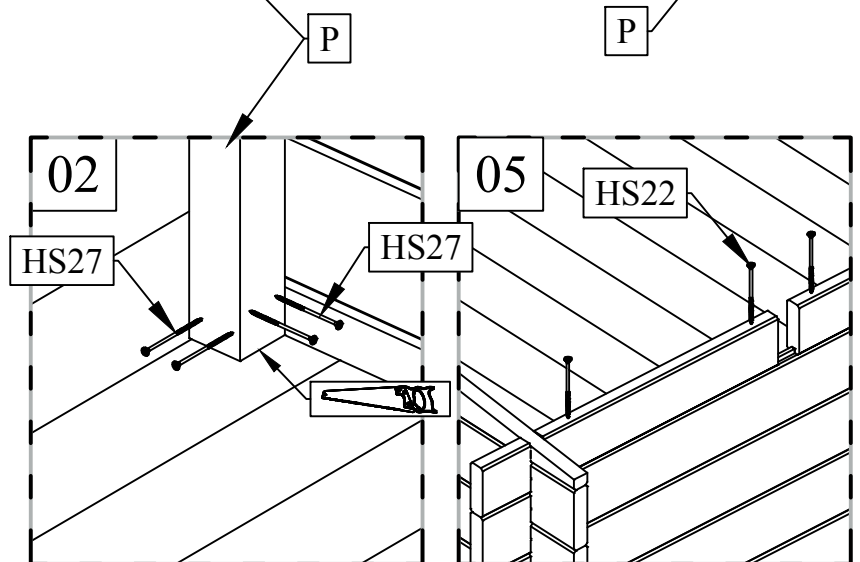
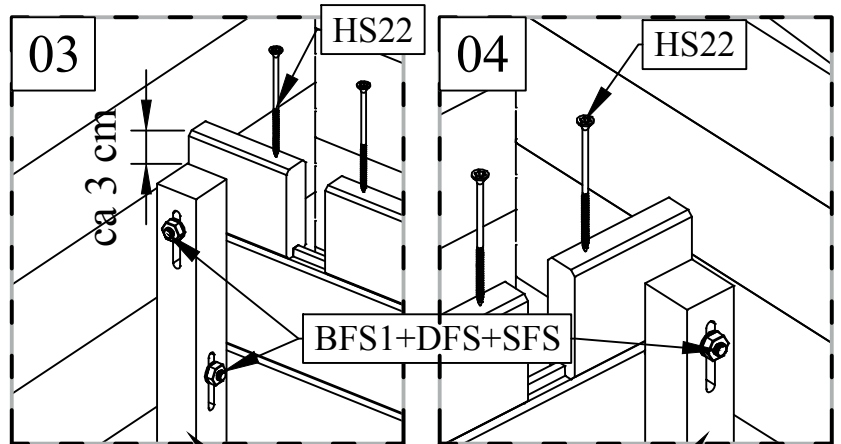
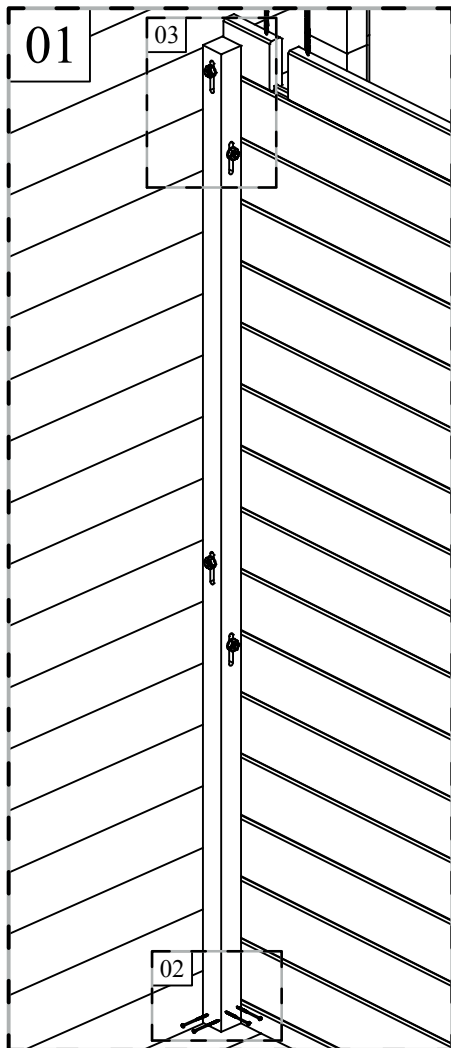
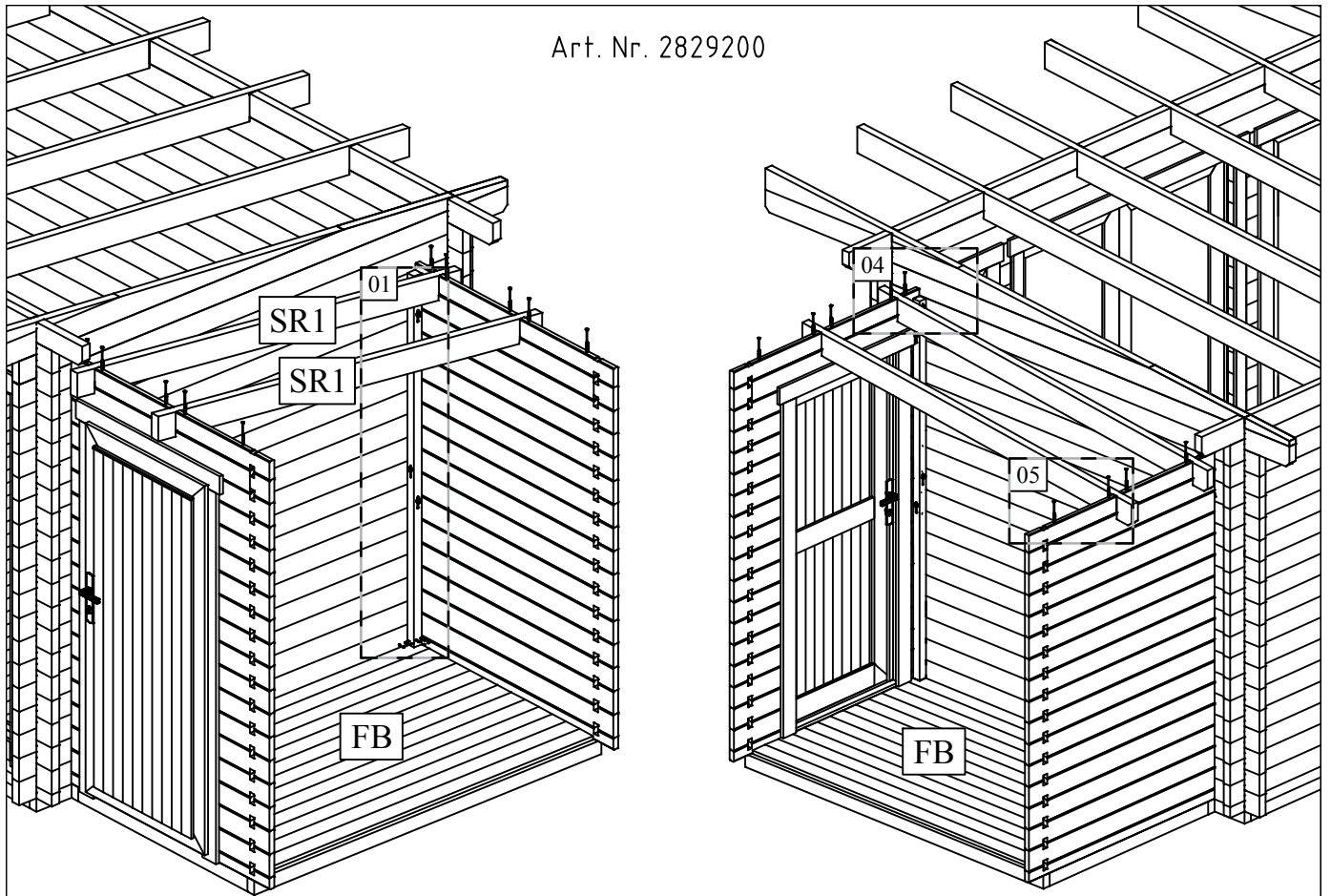

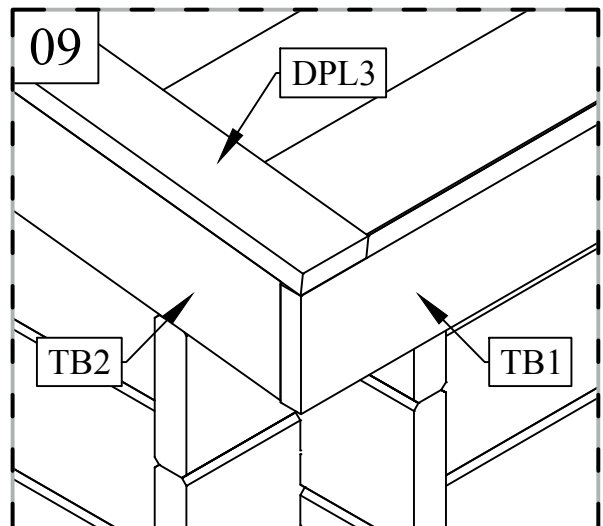
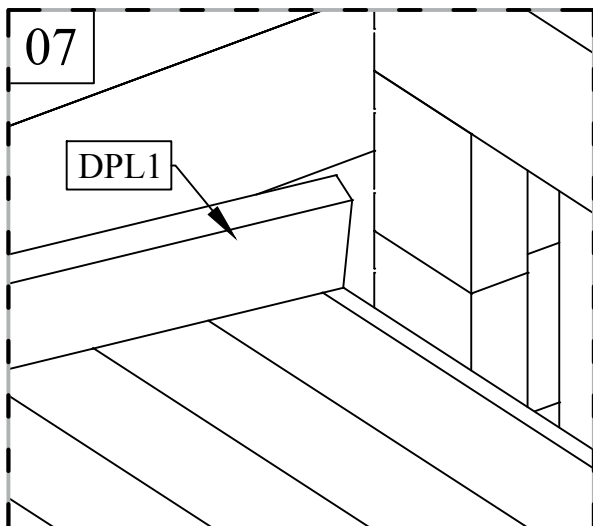
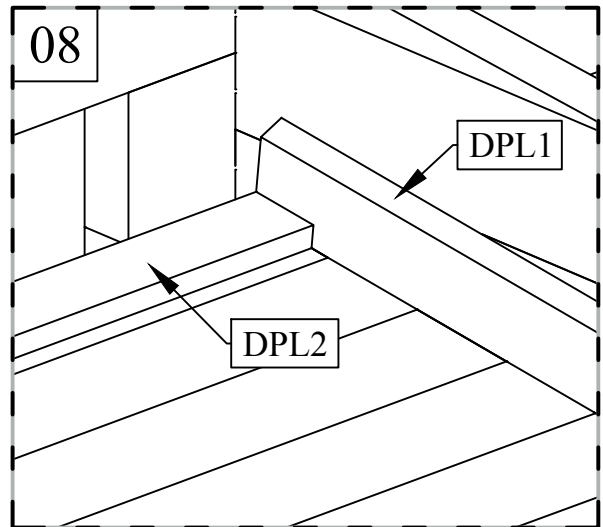
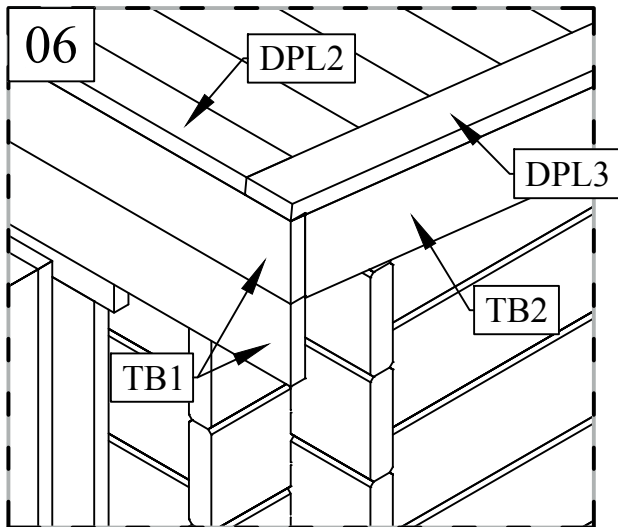
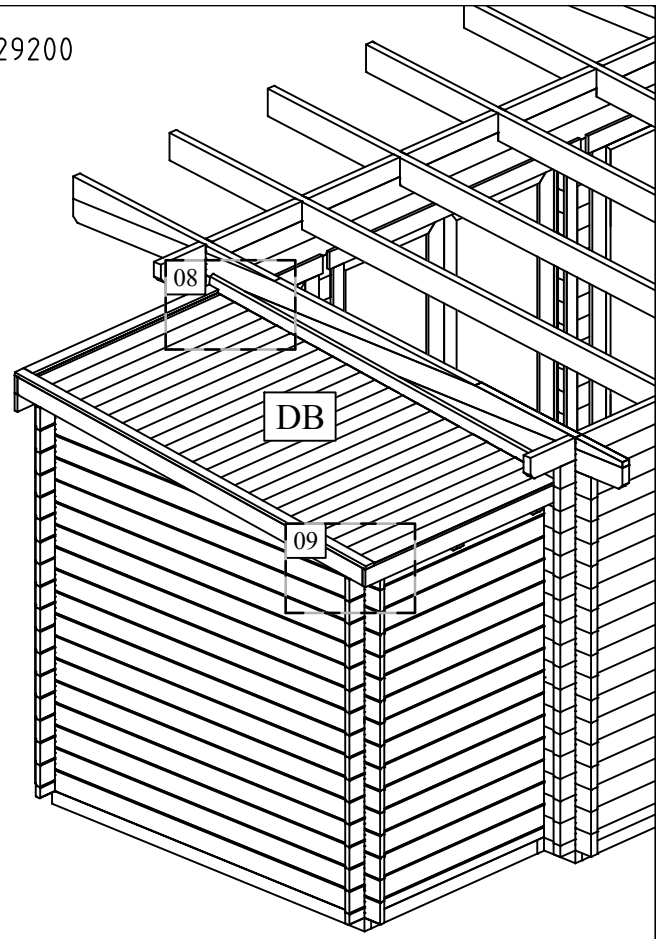
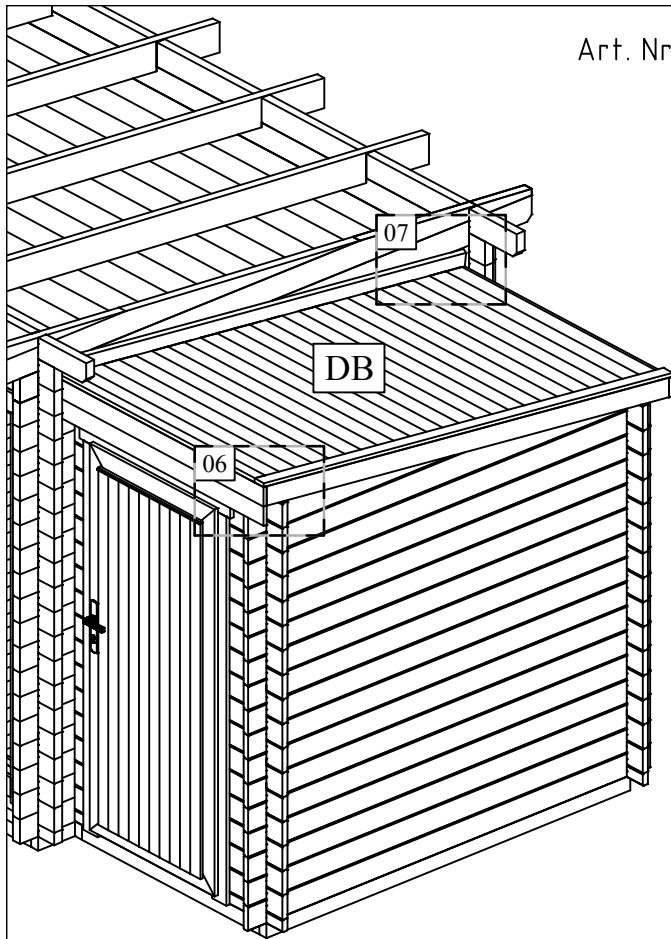





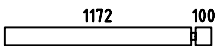

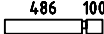
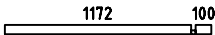
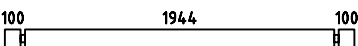
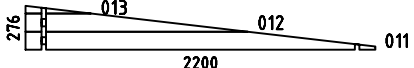
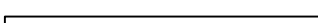
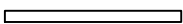
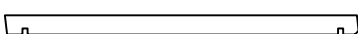

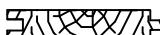



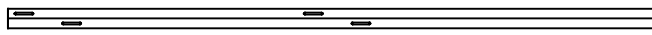
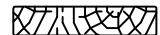
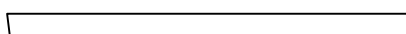

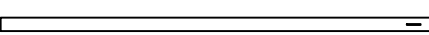

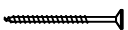
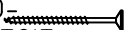

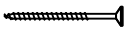
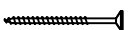

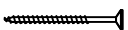
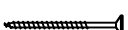
FLOOR BOARDS - FUSSBODENBRETTER -
PLAN POSE PLANCHER





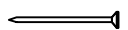
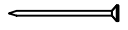
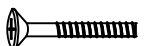
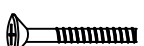

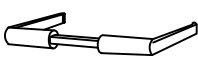
| Pos | 7.10.2016 | Piece list - Stückliste - Liste des pièces Art. Nr. 2829200 | 6/8 | Q | P (mm) | L (mm) |
|------|---|---|-----|----|-----------|-----------|
| 001 |  | | | 1 | 28x57 | 110 |
| 002 |  | | | 1 | 28x57 | 348 |
| 003 |  | | | 16 | 28x114 | 110 |
| 004 |  | | | 16 | 28x114 | 348 |
| 005 |  | | | 16 | 28x114 | 1300 |
| 006 |  | | | 2 | 28x90 | 110 |
| 007 |  | | | 2 | 28x90 | 488 |
| 008 |  | | | 2 | 28x90 | 614 |
| 009 |  | | | 1 | 28x57 | 1300 |
| 010 |  | | | 16 | 28x114 | 2200 |
| WA-1 |  | | | 1 | | |
| IAR1 |  | FOUNDATION - FUNDAMENT - FONDATION | | 2 | 45x70 | 1990 |
| IAR2 |  | FOUNDATION - FUNDAMENT - FONDATION | | 5 | 45x70 | 1110 |
| SR1 |  | RAFTER - DACHSPARREN - CHEVRON | | 2 | 44x120 | 2228 |
| FB | FLOOR BOARDS - FUSSBODENBRETT - LAME DE PLANCHER |  | | 13 | 90x18 | 1940 |
| DB | ROOF BOARDS - DACHBRETT - VOLIGES |  | | 25 | 90x18 | 1300 |
| FL | FLOOR FILLET - FUSSBODENLEISTE - CORNIERE DE FINITION DU PLANCHER |  | | | 18x18 | 6.22 |
| DPL1 | ROOFING FELT FILLET - DACHPAPPENLEISTE - BAGUETTE DE FIXATION DU FEUTRE BITUMEUX |  | | 1 | 18x70 | 2255 |
| DPL2 | ROOFING FELT FILLET - DACHPAPPENLEISTE - BAGUETTE DE FIXATION DU FEUTRE BITUMEUX |  | | 1 | 18x58 | 1242 |
| DPL3 | ROOFING FELT FILLET - DACHPAPPENLEISTE - BAGUETTE DE FIXATION DU FEUTRE BITUMEUX |  | | 1 | 18x58 | 2255 |
| P | STORM PROTECTION - STURMLEISTE - LATTE ANTI-TEMPETE |  | | 2 | 44x44 | 2030 |
| TB1 | FASCIA BOARD - TRAUFBRETT - BANDEAU DE TOIT |  | | 3 | 18x90 | 1318 |
| TB2 | FASCIA BOARD - TRAUFBRETT - BANDEAU DE TOIT |  | | 1 | 18x90 | 2225 |
| DRV | ROOF EDGE REINFORCEMENT - DACHRANDVERSTÄRKUNG - CORNIERE DE RENFORT DE BORD DE TOIT |  | | 1 | 28x34 | 1950 |
| KFS | STORM PROTECTION - STURMLEISTE - LATTE ANTI-TEMPETE |  | | 2 | 22x45 | 2050 |

| Pos | 7.10.2016 | Piece list - Stückliste - Liste des pièces Art. Nr. 2829200 | 7/8 | Q | P (mm) | L (mm) |
|------|---|---|-----|----|-----------|-----------|
| HS9 | SCREW FOR FASCIA BOARDS - SCHRAUBEN FÜR TRAUFBRETTER - VIS POUR FIXATION BANDEAU DE TOIT |  | | 32 | 3.5x50 | |
| HS12 | SCREW FOR ROOF EDGE REINFORCEMENT - SCHRAUBEN FÜR DACHRAND- VERSTÄRKUNG - VIS POUR FIXATION CORNIERE RENFORT DE BORD DE TOIT |  | | 5 | 4x40 | |
| HS13 | SCREW FOR ROOFING FELT FILLET - SCHRAUBEN FÜR DACHPAPPENLEISTE - VIS POUR FIXATION BAGUETTE DE FIXATION FEUTRE BITUMEUX |  | | 6 | 4x60 | |
| HS18 | SCREW FOR GABLE - SCHRAUBEN FÜR GIEBEL - VIS POUR FIXATION DES PIGNONS |  | | 3 | 5x120 | |
| HS18 | SCREW FOR RAFTER - SCHRAUBEN FÜR DACHSPARREN - VIS POUR CHEVRON |  | | 4 | 5x120 | |
| HS27 | SCREW FOR POST - SCHRAUBEN FÜR PFOSTEN - VIS DE FIXATION DES POTEAUX |  | | 8 | 5x70 | |
| HS16 | SCREW FOR 1. WALL BEAM - SCHRAUBE FÜR 1. BOHLENREIHE - VIS DE FIXATIONS 1ere RANGÉE DE MADRIERS AVEC POUTRELLES DE FONDATIONS |  | | 6 | 5x90 | |
| HS16 | SCREW FOR FOUNDATION - SCHRAUBEN ZUR BEFESTIGUNG FUNDAMENT - VIS DE FIXATIONS DES POUTRELLES DE FONDATIONS |  | | 12 | 5x90 | |
| HS22 | SCREW FOR WALL DETAILS - SCHRAUBE FÜR WAND DETAILS - VIS POUR MUR DETAILS |  | | 10 | 6x150 | |
| HS25 | SCREW FOR DOORSTEP - SCHRAUBEN FÜR SWELLE - VIS POUR FIXATION BARRE DE SEUIL |  | | 2 | 4.5x65 | |
| NF2 | ZN NAIL FOR FLOOR FILLET - ZN NÄGEL FÜR FUSSBODENLEISTE - POINTE POUR CORNIERE DE FINITION DU PLANCHER |  | | 12 | 1.4x40 | |
| SH28 | HAMMER BLOCK - SCHLAGHOLZ - CALLE DE FRAPPE |  | | 1 | | |
| SFS | NUT FOR STORM PROTECTION - SCHRAUBENMUTTER FÜR STURMLEISTE - ECROU POUR LATTE ANTI-TEMPETE |  | | 12 | D6 | |
| NF4 | ZN NAIL FOR ROOF - ZN NÄGEL FÜR DACHBRETTER - POINTE POUR FIXATION VOLIGES DE TOIT |  | | 84 | 2x50 | |
| NF4 | ZN NAIL FOR FLOOR - ZN NÄGEL FÜR FUSSBODENBRETTER - CLOUS POUR PLANCHER |  | | 70 | 2x50 | |
| NF5 | ZN NAIL FOR ROOFING FELT FILLET - ZN NÄGEL FÜR DACHPAPPENLEISTE - POINTE POUR BAGUETTE DE FIXATION FEUTRE BITUMEUX |  | | 10 | 2x40 | |
| BFS1 | BOLT FOR STORM PROTECTION - BOLZEN FÜR STURMLEISTE - BOULON POUR LATTE ANTI-TEMPETE |  | | 8 | 6x100 | |
| BFS2 | BOLT FOR STORM PROTECTION - BOLZEN FÜR STURMLEISTE - BOULON POUR LATTE ANTI-TEMPETE |  | | 4 | 6x60 | |
| DFS | WASHER FOR STORM PROTECTION - DICHTSCHEIBE FÜR STURMLEISTE - RONDELLE POUR LATTE ANTI-TEMPETE |  | | 12 | D6 | |
| TL4 | DOOR HANDLE FITTINGS - TÜRGRIF - POIGNEE DE PORTE |  | | 1 | | |
| TL5 | SET OF DOOR LOCK COVERS - SCHLOSSBLENDEN - SET DE GARNITURES DE PORTE |  | | 1 | | |
| | CYLINDER LOCK - ZYLINDERSCHLOSS - BARILLET DE PORTE |  | | 1 | 30x35 | |
| | | | | | | |
| | | | | | | |
| | | | | | | |

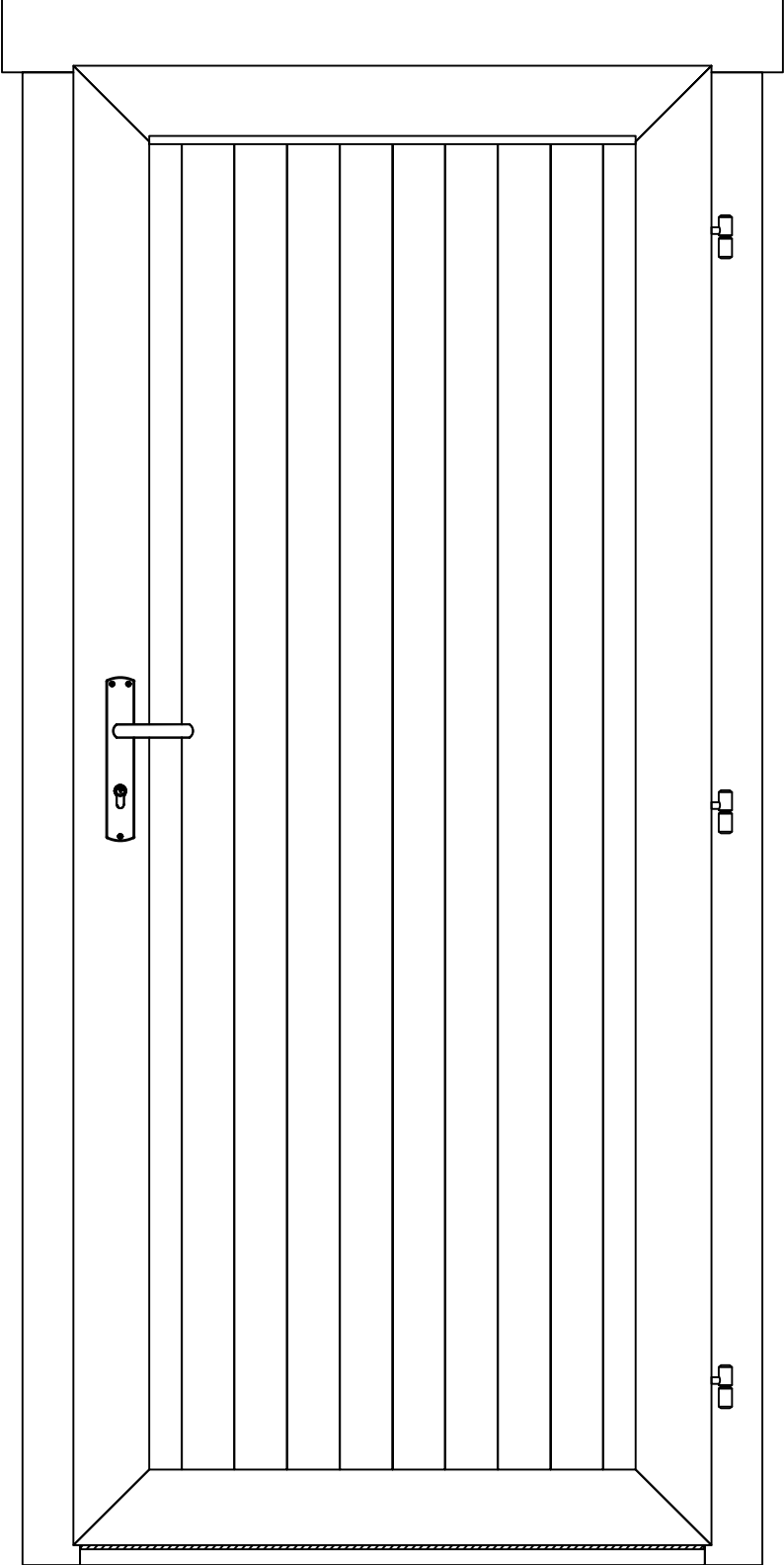
| Pos | 7.10.2016 | Piece list - Stückliste - Liste des pièces Art. Nr. 2829200 | 8/8 | Q | P (mm) | L (mm) |
|---|-----------------------------|--|-----|---|-----------|-----------|
| | DOOR - TÜR - PORTE 835x1850 | UL.2.100.IVP.MMWa TC+0 | | 1 | | |
|  | | | | | | |
| | | | | | | |
| | | | | | | |
| | | | | | | |
| | | | | | | |