

Torquay 44
Art. Nr. 4417502
1/10

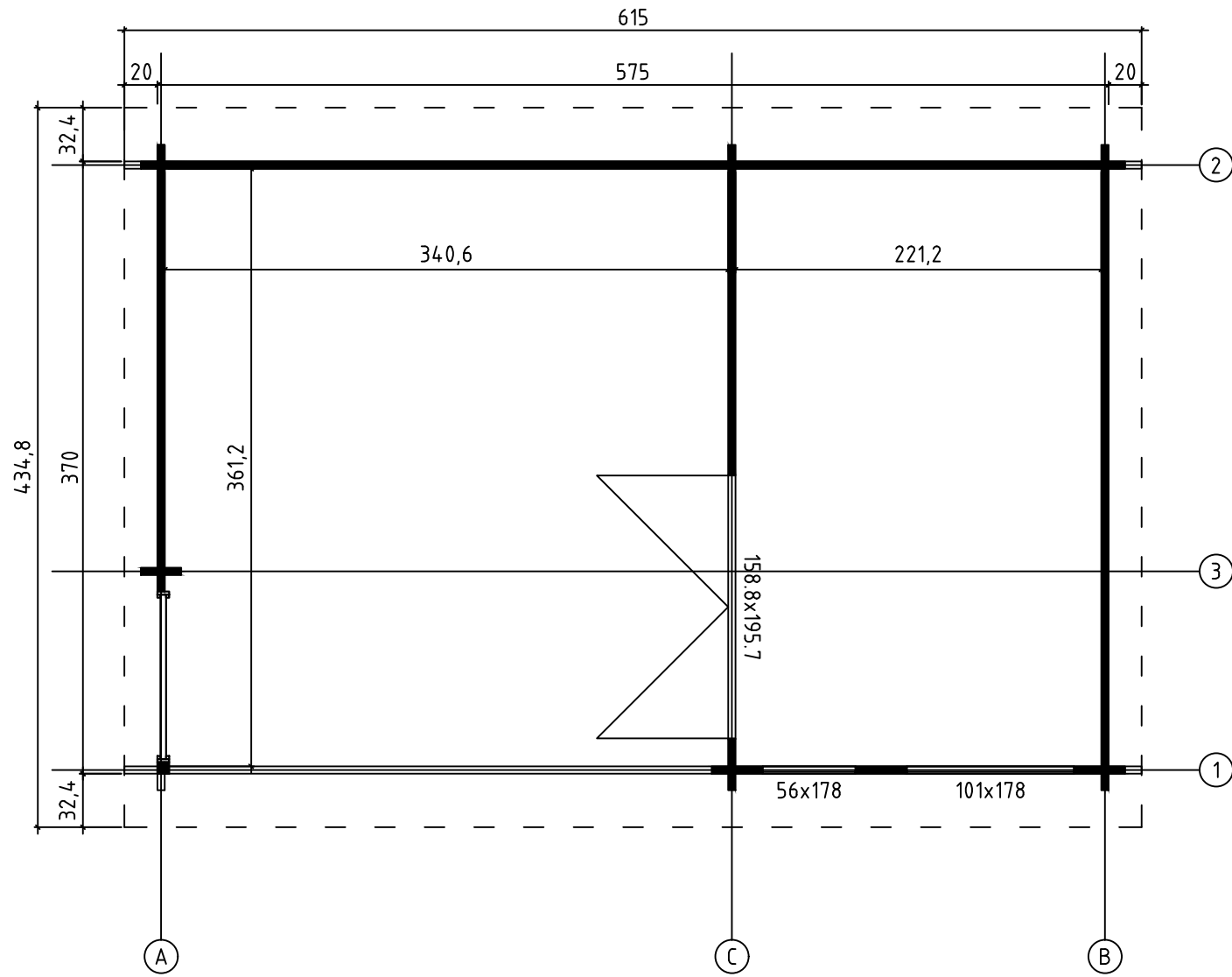

Art.Nr. 4417502

GROUNDPLAN - GRUNDPLAN - PLAN DE MASSE



FOUNDATION - FUNDAMENT - FONDATION

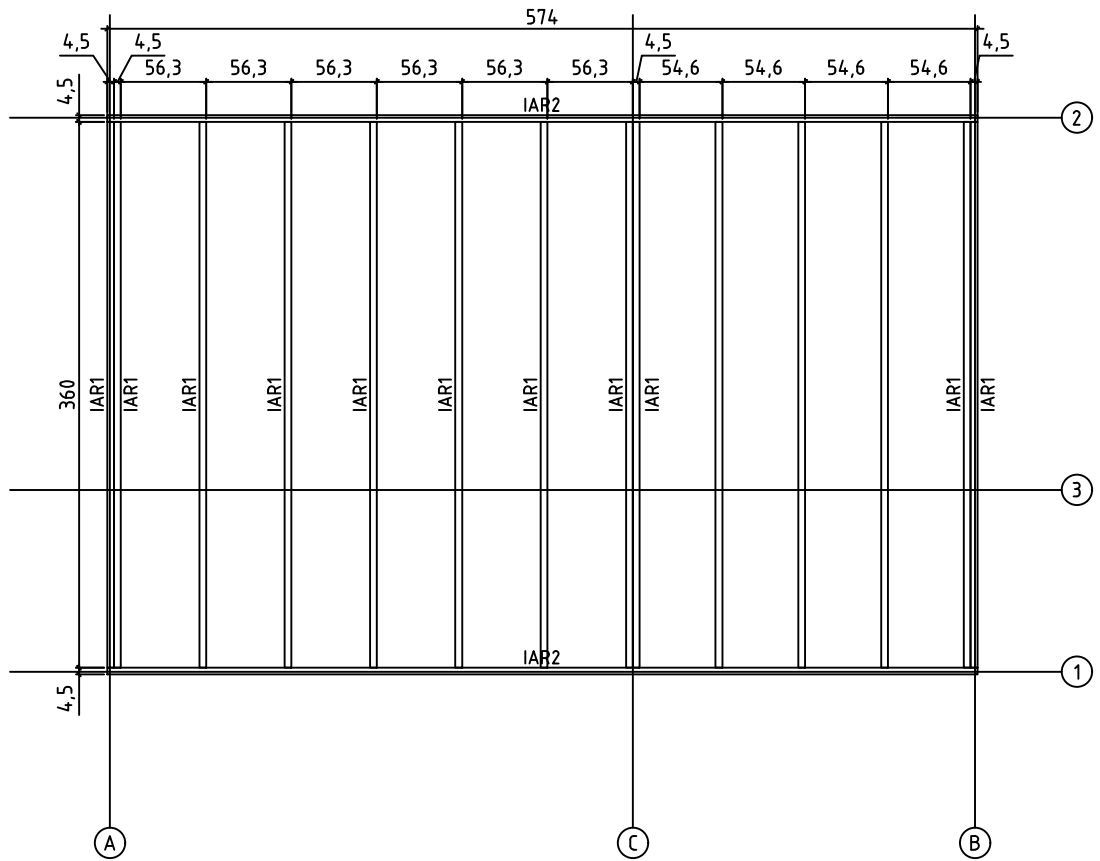



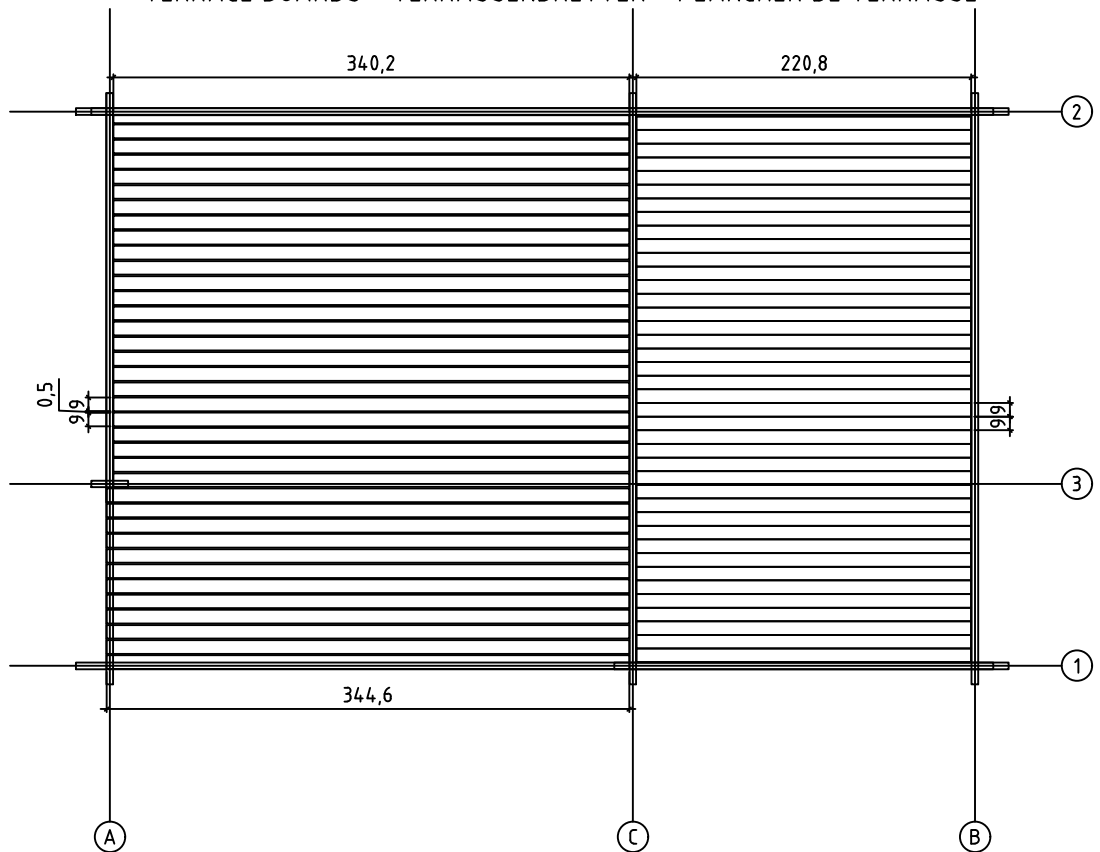

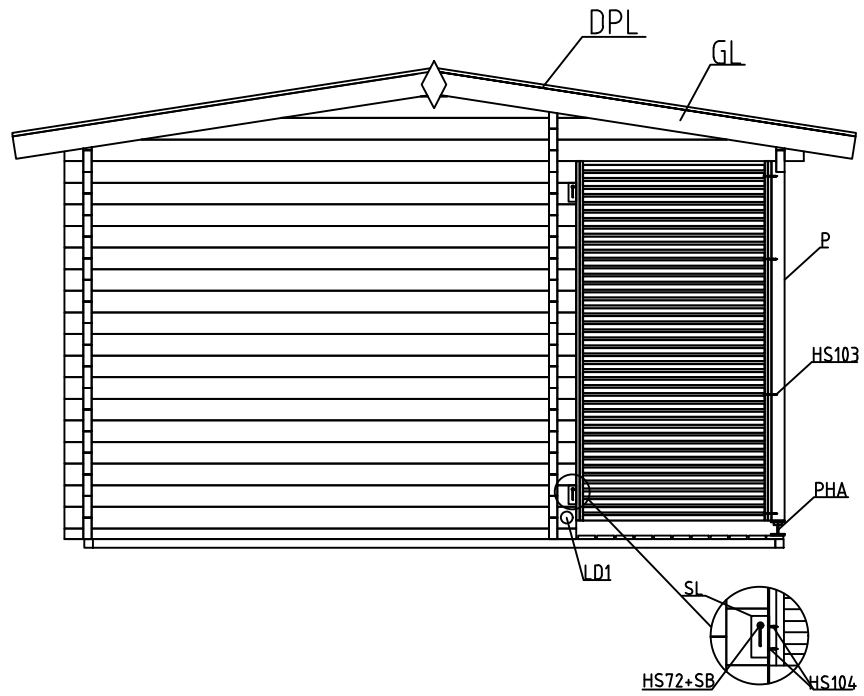
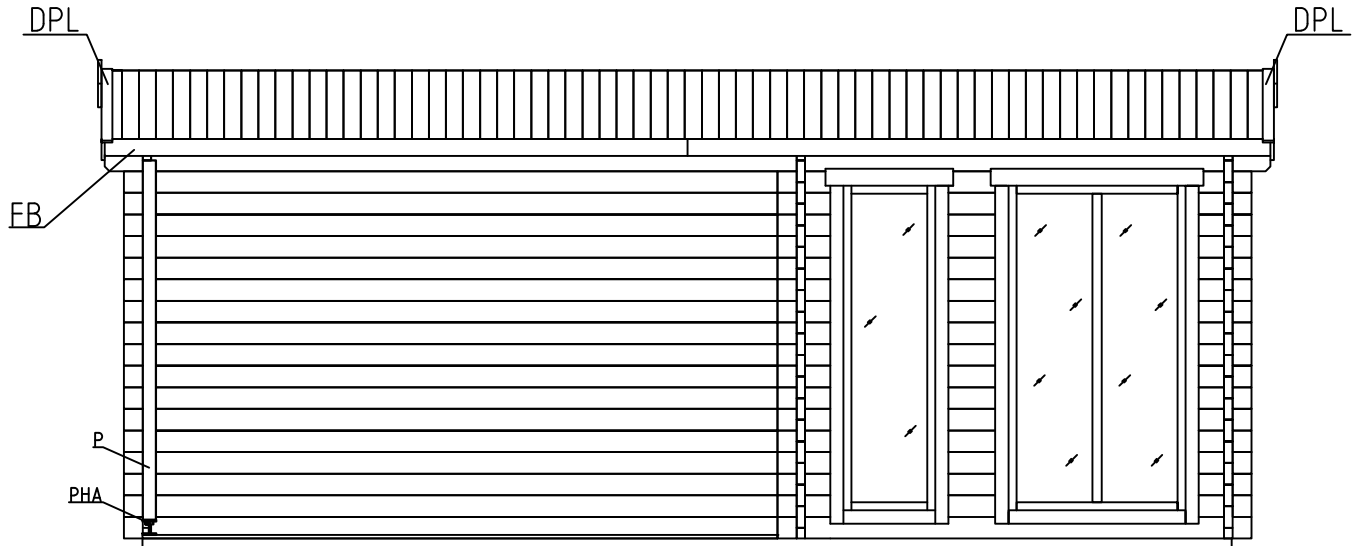

FLOOR BOARDS - FUSSBODENBRETTER - LAME DE PLANCHER
TERRACE BOARDS - TERRASSENBRETTER - PLANCHER DE TERRASSE

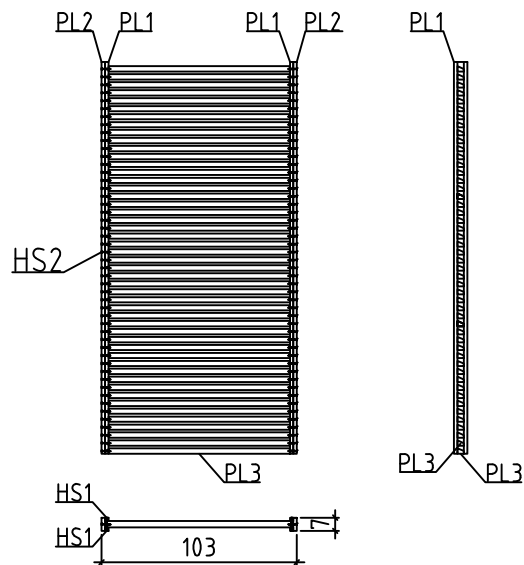

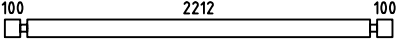

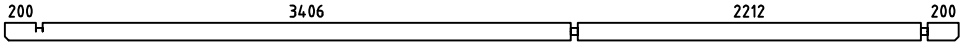
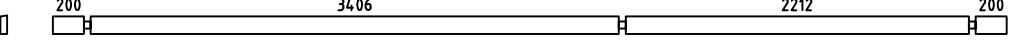
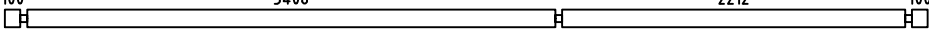
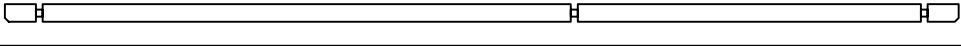
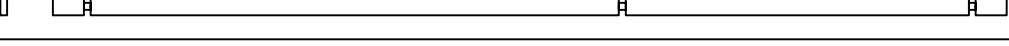

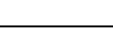
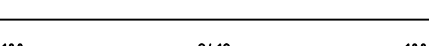
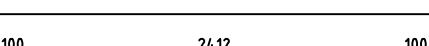
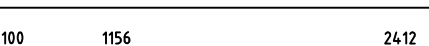
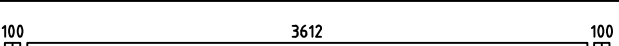
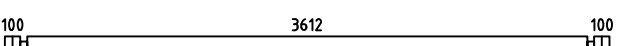

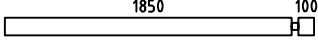
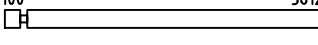
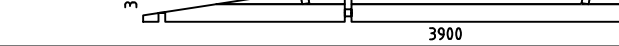
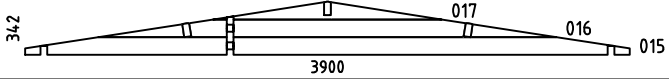
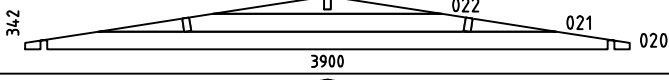
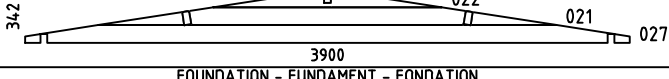
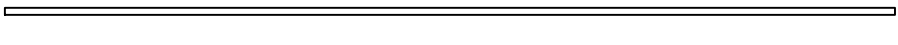
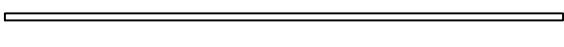



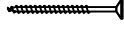
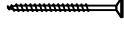

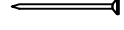

TERRACE RAILING - TERRASSE - GARDE-CORPS DE TERRASSE

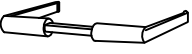

Pos	13.07.2016	Piece list - Stückliste - Liste des pièces Art.Nr. 4417502	7/10	Q.	P (mm)	L (mm)
001				1	44x114	2500
002				49	44x114	308
003				16	44x114	308
004				1	44x114	6150
005				1	44x120	6150
006				17	44x114	5950
007				1	44x114	6150
008				1	44x120	6150
009				20	44x114	244
010				1	44x77	244
011				1	44x57	2700
012				1	44x114	2700
013				16	44x114	2700
014				1	44x114	3900
018				1	44x57	3900
019				18	44x114	3900
023				1	44x57	308
024				1	44x57	1994
025				17	44x114	1994
026				1	44x114	3900
WA-1				1		
WB-1				1		
WC-1				1		
IAR2		FOUNDATION - FUNDAMENT - FONDATION 		2	45x45	5740
IAR1		FOUNDATION - FUNDAMENT - FONDATION 		14	45x45	3600

Pos	13.07.2016	Piece list - Stückliste - Liste des pièces Art.Nr. 4417502	8/10	Q.	P (mm)	L (mm)
PR1		ROOF BEAM - DACHBALKEN - PANNE DE TOIT 3406	2212	1	44x140	6150
A-PR1		ROOF BEAM - DACHBALKEN - PANNE DE TOIT 3406	2212	2	44x140	6150
	FLOOR BOARDS - FUSSBODENBRETTER - LAME DE PLANCHER			41	90x18	2208
	TERRACE BOARDS - TERRASSENBRETTER - PLANCHER DE TERRASSE			12	90x19	3446
	TERRACE BOARDS - TERRASSENBRETTER - PLANCHER DE TERRASSE			27	90x19	3402
	ROOF BOARDS - DACHBRETTER - VOLIGES			138	90x18	2200
	FLOOR FILLET - FUSSBODENLEISTE - CORNIERE DE FINITION DU PLANCHER				18x18	11.63
DPL	ROOFING FELT FILLET - DACHPAPPENLEISTE - BAGUETTE DE FIXATION DU FEUTRE BITUMEUX			4	18x58	2250
	TREADED ROD M10 - GEWINDESTANGE M10 - TIGE FILETÉE M10			3		180
	TREADED ROD M10 - GEWINDESTANGE M10 - TIGE FILETÉE M10			1		250
	TREADED ROD M10 - GEWINDESTANGE M10 - TIGE FILETÉE M10			4		2000
PL1	FILLET FOR TERRACE RAILING - LEISTE FÜR TERRASSE - BAGUETTE POUR CORPS DE TERRASSE			4	18x18	1896
PL2	FILLET FOR TERRACE RAILING - LEISTE FÜR TERRASSE - BAGUETTE POUR CORPS DE TERRASSE			2	18x70	1896
PL3	FILLET FOR TERRACE RAILING - LEISTE FÜR TERRASSE - BAGUETTE POUR CORPS DE TERRASSE			45	28x34	994
P	POST - PFOSTEN - POTEAU			1	70x70	1896
FB	FASCIA BOARD - TRAUFBRETT - BANDEAU DE TOIT			4	18x90	3075
	ROOF EDGE REINFORCEMENT - DACHRANDVERSTÄRKUNG - CORNIERE DE RENFORT DE BORD DE TOIT			4	28x34	3075
GL	GABLE MOULDING - GIEBELLEISTE - PLANCHE DE RIVE			4	18x120	2250
	WINDOW HANDLE FITTINGS - FENSTERGRIFF - POIGNÉE D'OUVERTURE DE FENETRE			1		
	BOLT FOR WINDOW HANDLE FITTINGS - BOLZEN FÜR FENSTERGRIFF BESCHLAG - BOULON POUR POIGNÉE D'OUVERTURE DE FENETRE			4		
LD1	LID FOR TREADED ROD HOLE - ABDECKUNG FÜR GEWINDESTANGENÖFFNUNG - COUVERCLE POUR ACCÈS RÉGLAGÉ TIGE FILETÉE			1		
	LENGTHENING BOLT FOR TREADED ROD - VERLÄNGERUNGSMUTTER FÜR GEWINDESTANGE - MANCHON DE RACCORDEMENT DE TIGE FILETÉE			4		
HS104	SCREW FOR SLIDING WALL TIE - SCHIEBEREGLER FÜR WAND - SABOT MÉTALLIQUE POUR FIXATION MUR			8	3.5x20	
	SCREW FOR GABLE SEGMENT - SCHRAUBEN FÜR DECKBLATT - VIS POUR FIXATION LOSANGE DE FINITION			4	3.5x35	
	SCREW FOR POST - SCHRAUBEN FÜR PFOSTEN - VIS DE FIXATION DES POTEAUX			2	3.5x50	

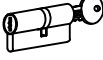
Pos	13.07.2016	Piece list - Stückliste - Liste des pièces Art.Nr. 4417502	9/10	Q.	P (mm)	L (mm)
		SCREW FOR GABLE MOULDING - SCHRAUBEN FÜR GIEBELLEISTE - VIS DE FIXATION POUR PLANCHE DE RIVE		24	3.5x50	
HS1		SCREW FOR COVERING MOULDING - SCHRAUBEN FÜR DECKUNGSPROFIL - VIS DE FIXATION PROFILS DE FINITION VERTICAUX A FIXER A L'EXTERIEUR DU CADRE DE LA PORTE		20	3x30	
		SCREW FOR DOOR FILLET - SCHRAUBE ZUR BEFESTIGUNG TÜRLEISTE - VIS D'ASSEMBLAGE DU CADRE DE PORTE		5	3x30	
HS103		SCREW FOR FIXING TERRACE RAILING - SCHRAUBE FÜR TERRASSE VIS DE FIXATION DE GARDE-CORPS DE TERRASSE		4	4.5x80	
HS2		SCREW FOR COVERING MOULDING - SCHRAUBEN FÜR DECKUNGSPROFIL - VIS DE FIXATION PROFILS DE FINITION VERTICAUX A FIXER A L'EXTERIEUR DU CADRE DE LA PORTE		90	4x40	
		SCREW FOR FASCIA BOARDS - SCHRAUBEN FÜR TRAUBRETTEN - VIS DE FIXATION POUR BANDEAU DE TOIT		28	4x40	
		SCREW FOR ROOF EDGE REINFORCEMENT - SCHRAUBEN FÜR DACHRANDVERSTÄRKUNG - VIS POUR RENFORT DE BORD DE TOIT		28	4x40	
		SCREW FOR ROOF BEAMS - SCHRAUBEN FÜR DACHBALKEN - VIS POUR PANNE DE TOIT		15	5x120	
		SCREW FOR GABLE - SCHRAUBEN FÜR GIEBEL - VIS POUR FIXATION DES PIGNONS		6	5x120	
		SCREW FOR 1. WALL BEAM - SCHRAUBE FÜR 1. BOHLENREIHE - VIS DE FIXATIONS 1ÈRE RANGÉE DE MADRIERS AVEC POUTRELLES DE FONDATIONS		10	5x90	
		SCREW FOR FOUNDATION - SCHRAUBEN ZUR BEFESTIGUNG FUNDAMENT - VIS DE FIXATIONS DES POUTRELLES DE FONDATIONS		40	5x90	
		SCREW FOR DOOR JAMB - SCHRAUBE FÜR TÜRRAHMEN - VIS DE FIXATION POUR MONTANT DE PORTE		4	5x90	
HS72		SCREW FOR SLIDING WALL TIE - SCHIEBEREGLER FÜR WAND - SABOT MÉTALLIQUE POUR FIXATION MUR		2	6x40	
		SCREW FOR POST HEIGHT ADJUSTMENT - SCHRAUBEN FÜR REGULIERUNGSSCHRAUBE FÜR PFOSTEN - VIS DE FIXATION DE SUPPORT RÉGLABLE DE POTEAU		8	6x50	
		SCREW FOR DOORSTEP - SCHRAUBEN FÜR SWELLE - VIS DE FIXATION DU SEUIL DE PORTE		3	4.5x65	
		ZN NAIL FOR FLOOR FILLET - ZN NÄGEL FÜR FUSSBODENLEISTE - POINTE POUR CORNIERE DE FINITION DU PLANCHER		25	1.4x40	
		HAMMER BLOCK - SCHLAGHOLZ - CALLE DE FRAPPE		1		
		DRIVE NUT TREADED ROD - EINSHLAGMUTTER FÜR GEWINDESTANGE - ÉCROU A FRAPPER POUR TIGE FILETÉE		4		
		NUT FOR TREADED ROD - MUTTER FÜR GEWINDESTANGE - ÉCROU POUR TIGE FILETÉE		4		
		ZN NAIL FOR TERRACE - ZN NÄGEL FÜR TERRASSENBRETTEN - POINTE POUR PLANCHER DE TERRASSE		546	2.1x50	
		ZN NAIL FOR ROOF - ZN NÄGEL FÜR DACHBRETTEN - POINTES DE FIXATIONS DES VOLIGES DE TOIT		444	2x50	
		ZN NAIL FOR FLOOR - ZN NÄGEL FÜR FUSSBODENBRETTEN - CLOUS POUR PLANCHER		210	2x50	
		ZN NAIL FOR ROOFING FELT FILLET - ZN NÄGEL FÜR DACHPAPPENLEISTE - POINTE POUR BAGUETTE FIXATION FEUTRE BITUMEUX		24	2x40	
		GABLE SEGMENT - DECKBLATT - LOSANGE DE FINITION		2		
		PLAIN WASHER TREADED ROD - UNTERLEGSSCHEIBE FÜR GEWINDESTANGE - RONDELLE PLATE POUR TIGE FILETÉE		4		

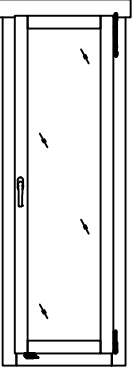
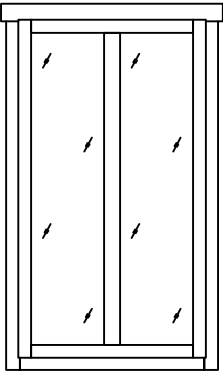
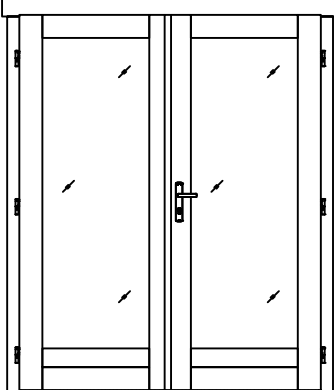
Pos	13.07.2016	Piece list - Stückliste - Liste des pièces Art.Nr. 4417502	10/10	Q.	P (mm)	L (mm)
SB		SLIDING WALL TIE - SCHIEBEREGLER FÜR WAND - SABOT MÉTALLIQUE POUR FIXATION MUR		2		
SL		SLIDING WALL TIE - SCHIEBEREGLER FÜR WAND - SABOT MÉTALLIQUE POUR FIXATION MUR		2		
		DOOR HANDLE FITTINGS - TÜRGRIFF - SET DE GARNITURES DE SERRURE DE PORTE		1		
		SET OF DOOR LOCK COVERS - SCHLOSSBLENDEN - SET DE GARNITURES DE SERRURE DE PORTE		1		
		CYLINDER LOCK - ZYLINDERSCHLOSS - CYLINDRE DE SERRURE		1		
		MALE BOLT HINGE FOR DOOR - TÜRRIEGEL - PARTIE MALE DE CHARNIERE DE PORTE		6	30x35	
PHA		POST HEIGHT ADJUSTMENT - REGULIERUNGSSCHRAUBE FÜR PFOSTEN - SUPPORT RÉGLABLE DE POTEAU		1		
		WINDOW - FENSTER - FENETRE 560x1780 AK.1.100.PSP DGP+		1		
		WINDOW - FENSTER - FENETRE 1010x1780 TAK.1.100.PM0.e DGP+		1		
		DOOR - TÜR - PORTE 1588x1957 TUK.1.100.PVP.MM DGP+		1		